

CHAIRMAN MAJORITY MEMBER

JUDICIARY

COMMITTEES

CITIES

CULTURAL AFFAIRS, TOURISM, PARKS
& RECREATION

FINANCE

HEALTH

RULES



**SENATOR
BRAD HOYLMAN**
27TH SENATORIAL DISTRICT
STATE OF NEW YORK

DISTRICT OFFICE:
322 EIGHTH AVENUE, SUITE 1700
NEW YORK, NEW YORK 10001
PHONE: (212) 633-8052
FAX: (212) 633-8096

ALBANY OFFICE:
ROOM 310
LEGISLATIVE OFFICE BUILDING
ALBANY, NEW YORK 12247
PHONE: (518) 455-2451
FAX (518) 426-6846

e-mail:
hoylman@nysenate.gov

website:
hoylman.nysenate.gov

**TESTIMONY RELATING TO THE NEW YORK CITY DEPARTMENT OF SOCIAL SERVICES
REQUEST FOR EXPRESSIONS OF INTEREST TO EXPAND AND REDEVELOP THE CITY'S
PUBLIC BURIAL PROGRAM**

**125 WORTH STREET, SECOND FLOOR AUDITORIUM, NEW YORK, NEW YORK 10013
OCTOBER 24, 2019**

Thank you for the opportunity to testify before you today. I'm State Senator Brad Hoylman and I represent the West Village, East Village, Stuyvesant Town and Peter Cooper Village, Chelsea, Hell's Kitchen, the Upper West Side, and Midtown. I'm also the only openly gay State Senator in New York. Because of Hart Island's complex history with the LGBTQ community and the HIV/AIDS epidemic in the 1980s, my constituents and I have a strong interest in the future of Hart Island and the outcome of this Request for Expressions of Interest (RFI) to expand and redevelop the City's public burial program.

I would like to thank the Department of Correction (DOC) and the Department of Transportation (DOT) for their efforts and coordination that allowed my staff to visit Hart Island, home of the DOC-run public burial program, which has helped to inform this testimony.

In 1985, before transmission of HIV and AIDS was fully understood, Hart Island began accepting bodies of LGBTQ New Yorkers who had died from complications caused by AIDS. The bodies were quarantined on the southern portion of the island and buried in mass graves separate from the other bodies, often in anonymity. A generation of LGBTQ New Yorkers was lost, stigmatized in life and in death, but not forgotten. Hart Island was often the only place these bodies could go: private burials were difficult to arrange because many funeral homes refused to handle corpses with HIV or AIDS.

It is thought that Hart Island is the final resting place for hundreds, if not thousands, of individuals with AIDS, the largest burial site of its kind in the country. It is important that this opportunity to redevelop the City's public burial program be used to make the site easily accessible for future generations of LGBTQ people to understand and connect with their community's history.

For centuries, Hart Island has served as a place for forgotten New Yorkers. In its history, at one time or another the island has been home to a Union Civil War prison camp, a psychiatric institution, a tuberculosis sanatorium, a homeless shelter, a boys' reformatory, a jail, a drug rehabilitation center, and of course, a potter's field for the City's unclaimed dead.

Today, the island continues to accept 1,000 to 1,200 bodies a year — thousands of stories of New Yorkers who couldn't afford a private grave or had no obvious next of kin and no burial wishes. Our

City and State must always strive to do better when serving our most vulnerable populations and that responsibility extends to the last dignity our government can be tasked with.

What should be a tranquil space for reflection and remembrance, Hart Island has become a monument to a darker time in New York City's history. Our current system of burial on a far-flung island with dozens of dilapidated buildings is frankly antiquated and distressing to see such a practice still exist in our City.

When my staff went to visit Hart Island last week, gunfire from the New York Police Department Rodman's Neck Firing Range could be heard across the Long Island Sound, even in front of the World War II Peace Monument. The irony was not lost on them. It took one of my staff members over two hours by train and bus from Brooklyn to reach the dock. The island is too inaccessible for many New Yorkers who want to visit loved ones and the infrequent hours of operation of the ferry further create barriers for visitation. The use of cheap labor by inmates incarcerated at Rikers Island raises many serious questions that must be addressed in the redevelopment of this program.

It is also clear the current program is not sustainable. At the current pace of burial, Hart Island will be out of space in 8 to 10 years. Any redevelopment of the public burial program must include a solution that increases the active life of the very limited space in our City. As was made clear in the aftermath of Super Storm Sandy in 2012, Hart Island is vulnerable to rising sea levels and even more severe storms.

A 2017 archeological assessment for the Hart Island Shoreline Stabilization Project following damage done by Super Storm Sandy paints a delicate picture of the island: human remains entangled in roots layered by centuries of buildings with different uses and unsecured, eroding shorelines. Seven years later, work is just beginning on this project. An island cemetery at risk of damage from climate change-related storms is not a long-term solution to burying our dead with dignity.

It was once said, "Show me the manner in which a nation cares for its dead and I will measure with mathematical exactness the tender mercies of its people, their respect for the laws of the land, and their loyalty to high ideals." If we are holding ourselves to the highest standard of mercy and respect, then I believe our current program on Hart Island has failed. We can and must do better for our most vulnerable New Yorkers.

I'm encouraged by this hearing, the initiation of the RFI, and I hope to continue this conversation with you as New York City evaluates and redevelops its public indigent burial program currently run by the DOC. I would like to thank the New York City Department of Social Services (DSS), DOC, Health and Hospitals (H+H), Department of Health and Mental Hygiene (DOHMH), the Office of the Chief Medical Examiner (OCME), and Department of Parks and Recreation (Parks) for their participation today. If there are any legislative steps you believe New York State should take in tandem with City redevelopment of the burial program, I would greatly welcome them. Please reach out to my office with your suggestions.

Thank you.

PUBLIC ADMINISTRATOR

**EDWINA FRANCES MARTIN, ESQ.
COMMISSIONER
PUBLIC ADMINISTRATOR**



**VINCENT ARGENZIANO
DEPUTY
PUBLIC ADMINISTRATOR**

RICHMOND COUNTY

**130 STUYVESANT PLACE, SUITE 402
STATEN ISLAND, NEW YORK 10301-2486**

**TEL: (718) 876-7228
FAX: (718) 876-8377**

Testimony of Richmond County Public Administrator

E d w i n a F r a n c e s M a r t i n, E s q.

**Before the New York City
Department of Social Services (DSS)**

Re: Hart Island and the City's Public Burial Process

Thursday, October 24th, 2019

**125 Worth Street, New York, NY
Second Floor Auditorium**

Good afternoon. My name is Edwina Frances Martin, I am the Commissioner and Public Administrator of Richmond County, and I thank you for scheduling this hearing regarding the future of Hart Island and New York City's Public Burial Process. I appreciate the opportunity to testify today regarding public burial in locations other than Hart Island and the department of social services' burial assistance program.

The Office of the Public Administrator is a New York City Agency created under the NYS Surrogate Court Act, and every borough in New York State has one. The Office of the Richmond County Public Administrator (hereafter, "RCPA") is responsible for the administration of estates of persons that have left no will and where there are no qualified person(s) to administer the decedent's estate. Uniquely, amongst other things, we provide for burial arrangements when no relative or family friend is available to do so. We also protect the decedent's property from waste, loss, or theft, and locate persons entitled to inherit from the estate. We are a revenue generating agency for the City, garnering over \$1.2 million for the City from fees associated with estates managed by the office since 2014.

In Fiscal Year 2018, thanks in large part to member item funding allocated by local elected officials, as well as donated services from Staten Island businesses, the RCPA arranged for the dignified burials of 71 Staten Island residents, including 32 still born infants, preventing the fate of their being buried on Hart Island as is the practice in the other four boroughs of New York City.

The Staten Island community supports, and indeed has come to expect, that all Staten Islanders, regardless of wealth or standing in life, deserve a burial (1) on Staten Island; (2) in a place that may be visited; (3) in an accurately-recorded gravesite; (4) from which the remains may be exhumed should a close family member subsequently come forward to do so; (5) by cemetery professionals; (6) in a quality casket; (7) in the thoughtful presence of those to whom care of their remains has been entrusted. Unfortunately, burial in a pauper's gravesite fails to ensure these elements of a dignified burial.

Honoring this long-time commitment requires the generosity of local funeral directors and cemeteries and the cooperation of area hospitals and care facilities and the Office of the Chief Medical Examiner. The RCPA also works closely with organizations and cemeteries that do not charge for plots for the burial of indigent persons and/or still born infants on non-titled land. For veteran decedents, we work with the Mayor's Office of Veterans Services to provide low or no-cost burials.

While graves and caskets are donated, there are still costs incurred, and the RCPA receives no budget allocation from the City of New York, nor is it reimbursed for the costs of burials. Indeed, the Human Resources Administration has stated that the Public Administrator may not access burial reimbursement funds, and while a designated “Friends of” organization, *The Foundation for Dignity*, was created to receive funds from the City towards the costs of indigent burial expenses on Staten Island, they have yet to be successful in receiving any from the Human Resources Administration. This is at least partly due to short timelines which make it difficult to obtain the necessary records from the nursing homes many of our decedent estates passed away in.

In sum, we rely on annual member item allocations and donations of professional services, caskets and gravesites from business owners to provide burials to Staten Island’s indigent decedents as well as still born infants. It is my hope that the process DSS is now engaging in, to review and reassess the services the city provides in connection with the burial of the indigent, will hopefully take into consideration the work of offices such as the RCPA, and the Foundation of Dignity, and reconsider how burial arrangements are reimbursed. In addition, the creation of an office to provide support to those in need of burial assistance, would, I believe, not only support the mission of the RCPA to ensure every Staten Islander is treated with dignity and compassion in connection with the burial of indigent residents, but could become another avenue of support for the work of the RCPA.

Once again, thank you for holding today’s hearing.



Edwina Frances Martin
Commissioner
Public Administrator



Legislative Affairs
One Whitehall Street
New York, NY 10004
212-607-3300
www.nyclu.org

TESTIMONY OF THE NEW YORK CIVIL LIBERTIES UNION CONCERNING PUBLIC BURIALS

October 24, 2019

The New York Civil Liberties Union (NYCLU) submits this testimony to support New York City's efforts to improve the experience of individuals connected to the City's public burial system and ensure that the administration of public burials comports with family and patient privacy.

The NYCLU, the New York State affiliate of the American Civil Liberties Union, defends and promotes the fundamental principles and values embodied in the Bill of Rights, the U.S. Constitution, and the New York Constitution. This includes the right to privacy, including medical privacy, as well as familial rights, including the opportunity to know where a loved one is buried and to visit a loved one's grave.

The NYCLU submits this testimony to address a subset of burials raising medical privacy concerns. New York City requires that a conceptus after 24 weeks gestation¹ be buried in the same manner as an individual.² In August, information came to light that publicly available databases, including the database maintained by the Department of Correction, that are used to locate gravesites on Hart Island not only included the names of the individuals buried on the island, but also identified conceptuses buried on the island by the names of patients who had experienced a stillbirth or abortion.³ By including patient names, the City breached critical aspects of patient confidentiality.

On August 22, Mayor DeBlasio committed to immediately changing the policies that led to this breach.⁴ Toward this end, the notice for this hearing explicitly inquired in question nine about "[r]ecommendations for changes to the system allowing the public to find burial information on Hart

¹ For the purposes of pregnancy dating, 24 weeks gestation typically occurs two weeks after the first day of the pregnant person's last menstrual period. This is consistent with state law; for example, the New York State Department of Health defines "commencement of pregnancy" as occurring "at conception," two weeks after the first day of the last menstrual period. Letter from Peter J. Millock, General Counsel, New York State Dep't of Health, to Elizabeth M. Navarra, American Medical Services 1 (Aug. 11, 1993) (on file with NYCLU) ("New York State defines the commencement of a woman's pregnancy to be the time of conception, which usually occurs two weeks after the first day of the last menstrual period.") Consequently, this requirement should apply 26 weeks after the pregnant person's last menstrual period.

² New York, NY, Public Health Code § 203.09.

³ Tess Riski, *New York City Has Been Releasing Burial Records of Fetal Remains—and Names of Women Linked to Them*, WALL STREET J., Aug. 21, 2019, <https://www.wsj.com/articles/new-york-city-has-been-releasing-burial-records-of-fetal-remainsand-names-of-women-linked-to-them-11566420004>.

⁴ @joeanuta, TWITTER (Aug. 22, 2019, 1:38 PM), <https://twitter.com/joeanuta/status/1164638071230554117>.

Island, that takes into consideration the public interest in searching such information and in protecting personally identifying information and medical privacy.”⁵ The NYCLU is pleased that the agencies are asking this question and urges the agencies to ensure that both patient privacy and the rights of those who wish to locate and visit loved ones at Hart Island are respected. The City can do this by developing a mechanism for patients who have lost or ended a pregnancy to identify the locations of gravesites without including patient identifiers in the publicly available database.

The NYCLU is well positioned to address the importance of both patient privacy and access to burial information and gravesites. In *Lusero v. City of New York*, the NYCLU successfully represented individuals who were barred from visiting the graves on the island. The named plaintiff in that case, Ms. Lusero, sought to visit the burial site of her stillborn child.⁶ Indeed, as part of the *Lucero* settlement, the City agreed to maintain a publicly accessible database for members of the public to locate loved ones buried on Hart Island – an important tool for family members and also a source of the current privacy violations.

It is, of course, critical that the City continue to ensure robust access to burial information and gravesites. However, the subset of burials identified by patient name poses threats to living individuals. Patient responses to pregnancy outcomes are highly dependent on each individual patient’s circumstances, and including patient names in the database without explicit consent can have serious consequences.

Miscarriage, stillbirth, and abortion are common experiences,⁷ and yet they remain stigmatized in the United States and throughout the world.⁸ As a result, while abortion is a normal part of health care, patients and health care providers regularly experience threats, harassment, and violence,⁹ and individuals have been fired from their jobs for having abortions.¹⁰

⁵ NOTICE OF PUBLIC HEARING REGARDING PUBLIC BURIALS, N.Y. CITY DEP’T OF SOC. SERV. (2019).

⁶ See generally Complaint, *Lusero v. City of New York*, No. 14 Civ. 9533 (S.D.N.Y. Dec. 3, 2014).

⁷ As many as one in five pregnancies ends in miscarriage, *Miscarriage*, MAYO CLINIC, <https://www.mayoclinic.org/diseases-conditions/pregnancy-loss-miscarriage/symptoms-causes/syc-20354298> (last visited Oct. 16, 2019), one percent of pregnancies end in stillbirth, *Stillbirth*, MARCH OF DIMES, <https://www.marchofdimes.org/complications/stillbirth.aspx> (last visited Oct. 16, 2019), and one in four women will have an abortion by age 45, *Induced Abortion in the United States*, GUTTMACHER INST., Sept. 2019, <https://www.guttmacher.org/fact-sheet/induced-abortion-united-states>.

⁸ See generally Katherine Martinelli, *Miscarriage is common. So why is it such an isolating experience*, WASH. POST, Oct. 13, 2016, <https://www.washingtonpost.com/news/parenting/wp/2016/10/13/talking-about-miscarriage-might-be-upsetting-but-we-need-to-do-it/>; Alison Norris, Danielle Bessett, Julia R. Steinberg, Megan L. Kavanaugh, Silvia De Zordo, & Davida Becker, *Abortion Stigma: A Reconceptualization of Constituents, Causes, and Consequences*, 21 WOMEN’S HEALTH ISSUES S49 (2011).

⁹ See generally Jill Heaviside & Rosann Mariappuram, *The Escalation of Anti-Abortion Violence Ten Years After Dr. George Tiller’s Murder*, REWIRE, May 31, 2019, <https://rewire.news/article/2019/05/31/the-escalation-of-anti-abortion-violence-ten-years-after-dr-george-tillers-murder/>; Violence Statistics & History, NAT’L ABORTION FED., <https://prochoice.org/education-and-advocacy/violence/violence-statistics-and-history/> (last visited Oct. 16, 2019); Julia Turkewitz & Jack Healy, *3 Are Dead in Colorado Springs Shootout at Planned Parenthood Center*, NYTIMES, Nov. 27, 2015, <https://www.nytimes.com/2015/11/28/us/colorado-planned-parenthood-shooting.html>; 2018 NATIONAL CLINIC VIOLENCE SURVEY (Feminist Majority Foundation 2019).

¹⁰ E.g. Michelle Baker, *Why You Can’t Get Fired for Having an Abortion: The Latest Sex Discrimination Ruling From a Louisiana Federal Court*, July 26, 2019, NAT’L WOMEN’S L. CTR, <https://nwlc.org/blog/why-you-cant-get-fired-for-having-an-abortion-louisianas-latest-sex-discrimination-ruling/>.

For these reasons, New York has long protected the confidentiality of abortion patients.¹¹ Beyond this specific requirement, medical privacy laws at the state and federal level support the right of individuals to keep their medical information private.¹² Releasing patients' names without consent violates these laws.

The history of Hart Island is worth understanding and preserving. There are millions of individuals connected to Hart Island, each with their own story. And while all of these individuals have a right to know where a loved one is buried on Hart Island and to visit a loved one's grave, this interest can and should be accomplished while maintaining patient confidentiality. To this end, the NYCLU urges the City to develop a mechanism for patients who have lost or ended a pregnancy to identify the locations of gravesites without including patient identifiers in the publicly available database.

Importantly, though, this issue is not unique to Hart Island. Any future public burial site must provide a mechanism for individuals – including those who have lost or ended a pregnancy – to locate gravesites while maintaining patient privacy. Moreover, while this testimony addresses the NYCLU's interest in patient privacy, the NYCLU remains concerned about robust access to gravesites, the subject of the NYCLU's initial lawsuit. The NYCLU has shared recommendations with regard to gravesite visitation and City plans for transportation in testimony before the City Council; that testimony is attached as an appendix to this document.

The NYCLU thanks the Department of Social Services, Health and Hospitals, the Department of Health and Mental Hygiene, the Department of Correction, the Office of the Medical Examiner, and the Department of Parks and Recreation for holding this hearing and taking a hard look at these important issues. The NYCLU stands ready to assist the agencies as they move forward.

¹¹ N.Y. Gen. Bus. Law § 394-e (McKinney 2017).

¹² To the extent that health care providers share patient information with the Hart Island database, they may be in violation of the federal Health Insurance Portability and Accountability Act (HIPAA), which requires patient consent before providers share their health information. 42 U.S.C. 1320d-2 note. State law also limits public entities, including public hospitals, from disclosing individuals' personal information without their consent, *see* N.Y. Pub. Off. Law § 96 (McKinney), and New York considers the "disclosure of items involving the medical . . . records of a . . . patient in a medical facility" an "unwarranted invasion of personal privacy." N.Y. Pub. Off. Law § 89(2)(b) (McKinney). In addition, New York's patient bill of rights underscores the importance of individual privacy, insisting that "[e]very patient shall have the right to have privacy in treatment and in caring for personal needs . . . [and] confidentiality in the treatment of personal and medical records." N.Y. Pub. Health Law § 2803-c(3)(f) (McKinney).

Appendix



Christopher Dunn
Legal Director
212.607.3300 ext. 326
cdunn@nyclu.org

**TESTIMONY OF THE NEW YORK CIVIL LIBERTIES UNION
CONCERNING PUBLIC ACCESS TO GRAVESITES
ON HART ISLAND**

May 30, 2019

The New York Civil Liberties Union submits this testimony in support of legislative efforts to increase public access to the gravesites on Hart Island, which is New York City's potter's field where about one million people are buried. As the New York affiliate of the American Civil Liberties Union, the NYCLU is dedicated to protecting and advancing civil rights and civil liberties on a wide range of issues, including the right of individuals to associate with family members and others with whom they have close personal relationships. Restrictions on the ability of persons to visit the gravesites of their loved ones implicates this fundamental right of familial and personal association.

The NYCLU has a unique perspective on the legislation pending before the Council as a result of the NYCLU having legally challenged the New York City policy and practice of barring all visits to gravesites on Hart Island and having monitored gravesite visits that have taken place since 2016 as a result of our case. Specifically, in December 2014 the NYCLU filed a federal class action lawsuit (*Lusero v. City of New York*) on behalf of tens of thousands of family members – including children, parents, brother and sisters, grandparents, grandchildren, cousins, aunts and uncles, and nieces and nephews -- of those buried on Hart Island. Under a settlement the court approved in February 2016, the City is required to take various steps to permit and facilitate gravesite visits to Hart Island, including the following:

- Allow up to 70 people to visit to Hart Island gravesites one weekend day each month;

- Provide ferry service from City Island to Hart Island for gravesite visits;
- Maintain an online and telephone system by which individuals can reserve spots on the ferry to Hart Island for gravesite visits;
- Allow visitors to leave at gravesites personal mementos such as flowers, small stuffed animals, prayer cards, photographs, small flags, and blankets;
- Maintain a publicly accessible database for members of the public to locate persons buried on Hart Island.

In addition, after finalization of the settlement the Department of Correction agreed to the NYCLU's request to allow photographs to be taken at gravesite visits.

Meaningful as these reforms are, they fall well short of what the City should be doing to facilitate public access to a burial ground of around one million poor New Yorkers. Most significantly, it remains very difficult for members of the public to gain access to Hart Island because of the 70-person, one-weekend-per-month limit on visitors and because the only access to the island is via a ferry departing from City Island, which itself is far removed from convenient public transportation. Relatedly, while the Department of Correction has made a good-faith effort to fine-tune the reservation system that schedules the limited visits, that system has created an untenable situation in which people claim limited visitation slots but do not show up while those who wish to visit cannot do so because all slots have been reserved in advance.

A second major problem with the current visitation arrangement is that all gravesite visitors are subject to physical search by Department of Correction officers at the ferry and then must be accompanied by an officer to the gravesite, both of which result from Hart Island being under the jurisdiction of the Department of Correction and from the City using inmate labor to do Hart Island burials. While in our experience DOC personnel have been professional and courteous, no one visiting a loved one's grave should be treated as a prison visitor. Further

exemplifying this issue, gravesite photographs are restricted to those taken by corrections officers using a camera the department purchased.

Given this situation, we fully support fundamental reform to New York City's operation of Hart Island. Specifically, we call on the Council to do the following:

1. Allow members of the public to visit Hart Island gravesites throughout the week without numerical limits and without having to make advance reservations;
2. Provide regular ferry service to Hart Island, both from City Island and from other points around the city;
3. End the current regime of requiring gravesite visitors to be accompanied by city employees – be they Department of Correction officers or any other type of employee.

With respect to the proposed legislation now before the Council, Int. No. 906's transfer of Hart Island from the Department of Correction to the Department of Parks and Recreation presumably would be an important step towards eliminating the numerical visits on gravesite visits and eliminating visitors being searched and accompanied by armed law-enforcement officers. With that understanding, we support that bill.

As for Proposed Int. No. 909-A's requirement that the Department of Transportation develop within one year a transportation plan to increase ferry service to Hart Island, the NYLCU fully supports increased ferry access to the island. We see no reason, however, why it should take a year to develop such a plan and call on the Council to require that the plan to developed much more quickly, preferably within 90 days. We also believe the bill should be clearer in requiring not only the development of a plan but the actual implementation and maintenance of the plan.¹

¹On the related bills that would create a public burial task force (Int. No. 1580) and that would create an office of burial support (Int. No. 1559), the NYCLU takes no position because it has no particular expertise bearing on those matters.



111 WASHINGTON AVENUE, SUITE 501

ALBANY, NEW YORK 12210

PHONE: (518) 434-1134

FAX: (518) 427-0452

WEBSITE: NYSAC.COM

**Testimony of David Fleming, Jr.
Acting Executive Director
New York State Association of Cemeteries
October 24, 2019**

Good afternoon. My name is David Fleming and I'm the Acting Executive Director of the New York State Association of Cemeteries (NYSAC) which represents New York's not-for-profit cemeteries of every size and location in the Empire State. Thank you for holding this information gathering session today and for exploring the next chapter in handling indigent burials in New York City.

By way of background, in addition to the extensive policy work of NYSAC in cemetery regulation and consumer protections, I would also note that personally, I have a comprehensive twenty-four year background in general cemetery management, crisis management, and government affairs. I have had the opportunity to represent large as well as some of the smallest cemeteries during my professional career and I have personally operated three Upstate municipal cemeteries.

I have also been called on by local governments to handle cemetery abandonment cases and have successfully implemented the restructuring of the largest cemetery abandonment reorganization and restoration in state history.

During my cemetery management and advocacy career, I have published numerous cemetery articles and have been asked to speak at state and international conferences on cemetery legislative advocacy and governmental cooperation. My white paper on cemetery restructuring and abandonment, published by the Tug Hill Commission, is the New York industry standard.

Additionally, during more than twenty years of advocating cemetery interests, I've been honored to have negotiated some of the most significant changes in cemetery policy in New York which are now utilized as national models for cemetery regulation. I'm also recognized as the author of legislative efforts to completely rewrite New York's cremation regulation and operations law.

NYSAC's legislative successes include changes from financial regulation of cemeteries to reclamation of graves to the original introduction of New York's "Death Care Proxy." Our recent efforts have included the passage of New York's Pet Cremated Remains Bill which has garnered international attention.

It is with this background in mind that we seek to provide input in this RFI relating to indigent and unclaimed human remains.

As the City is aware, New York City is limited to how it may handle indigent and unclaimed burials. Our research has confirmed the significant number of exhumations and removals conducted on the island each year. The process and options for disposing of human remains is limited for a municipality but it also comes with a social contract with families seeking to honor their loved ones and to reclaim remains as well.

New York State has the most significant consumer protections in the nation related to disposition of human remains. This includes identification and record keeping, as well as general consumer protections. Should the City seek to locate burials outside of New York, such as New Jersey, the City would encounter serious problems. New Jersey's laws and rules in this domain are quite limited when compared to New York. This of course does not even address the tremendous inconvenience for New York City residents that seek to visit the final resting place of their loved ones or even being sure that out of state burials will guarantee the true location of their loved ones.

It is important to note that those buried under the City's direction or authority are some of the most vulnerable in our society. In many instances, surviving family members also are among our most vulnerable. Providing access locally for families to mourn and memorialize should be a critical goal of this RFI and any subsequent RFP.

New York City already has extensive burial opportunities on Hart Island if they choose to be open to the more practical mechanisms of modern cemetery operation. While the City does not possess this state of the art technology or training in burial practices or technology, other cemeteries and cemeterians do.

From the outside professionals view, Hart Island has sufficient burial space for many years and at the same time, provides options for public access for parkland and recreation. This combination of uses may be implemented utilizing City resources as well as outside professional cemetery operations experience on a contractual basis.

My recent visit to Hart Island provided evidence of numerous additional burial locations, areas for grave reclamation as well as expanded areas for community access. Previous reports and investigations have also shown a number of areas to be reclaimed from prior uses which will provide enhanced burial options for the City and the families they serve.

Hart Island is and has been, essentially a green burial space. Through modern burial management by professionals, this island may provide efficient and respectful disposition, opportunities and the very real possibility for memorialization of those interred on the island.

Sufficient work areas already exist for modern cemetery operations. These sites may even be relocated into smaller areas in a long term plan for reclamation of unused grave or green space while still providing beautiful park land and vistas.

Over the last decade, there have been numerous articles published about the filling up of traditional not-for-profit cemeteries in the five boroughs. This is nothing new. This fact is hard to avoid and it is as old as the City itself. As cemeteries have filled, they have either been moved (such as in the case of Washington Square Park and many others) or land further and further out was utilized for burials. This practice has led to numerous surrounding counties having state legislation passed to limit the acreage of cemeteries surrounding New York City to prevent such areas from being the vast burial grounds for the metropolitan New York.

The not-for-profit cemeteries within and around New York are well run and are professional organizations that seek to provide the highest care for the families they serve. However, they are also low on valuable space and are transitioning to other interment options that the City is prohibited from providing for indigent and unclaimed remains.

Hart Island is a practical alternative to providing green burial services and enhanced park access for residents of New York City.

Utilizing outside experts to provide the modern burial operations at Hart Island and thereby alleviating the pressure on City departments under the current scheme, would also be a significant benefit to the families the island has served and will need to serve.

These changes may be made in conjunction with existing City operations. It is strongly encouraged that outside assistance provided by members of the cemetery industry will be able to enhance options for burial and services on the island.

Thank you for the opportunity to provide this information and I stand ready to provide any further information you may require.

NYC Public Burial Testimony
NYC Department of Social Services
October 24, 2019

Melinda Hunt, President
The Hart Island Project
P.O. Box 4327
New York, NY 10163
melinda@hartisland.net
914-402-5992

Thank you for permitting me to testify. My name is Melinda Hunt. I am the founding director of The Hart Island Project a public charity whose mission is to increase transparency and access to public burials on Hart Island. I bring 28 years of experience documenting the burial process on Hart Island and working with volunteers, families and friends of the buried.

When I first visited Hart Island in 1991, Correction Officers informed me that they could only disinter recent burials, ten years or less. In 2005, I attended a homicide trial in New Jersey for a young woman who had been buried for twenty years. From skeletal remains alone, prosecutors were able to prove homicide. It was extremely important for the family of that deceased young woman to learn what had happened to her 24 years after her disappearance. Being able to retrieve bodies and return them to families is an important service that we want to preserve.

This raises the question of how long the graves should remain intact before reuse? Up until 1977, when a fire destroyed burial ledgers stored on Hart Island, reuse of burial sites after twenty-five years was the practice. The reason over a million bodies have been continuously interred on Hart Island for 150 years is that graves on public land can be recycled once the body is fully decomposed to skeletal remains. Because there is enough land on Hart Island to bury all unclaimed and unidentified bodies for at least 25 years, New York City has never run out of burial space and will never run out of burial space. I believe it is important to return remains to families for up to 25 years but not indefinitely. The city must be able to recycle the gravesites so that we have enough land to continue burials indefinitely.

In 1992 I began working on a book about Hart Island with cooperation of the Department of Correction. At that time, DOC informed me that there was eight to ten years left of burial space on Hart Island. This was the peak of the AIDS epidemic and there were three times as many burials on Hart Island as there are today. Even if the city does not immediately resume recycling gravesites older than 25 years, there is still enough land to available for burials for several decades. Landscape architect, Ann Sharrock projects that there is 80 years left of new burial space at the current rate of 1000-1200 burials per year.

In 2015, the Department of Buildings and the Parks Department produced a report (attached) recommending demolition for all but two of the buildings. Removal of the buildings listed in this report would provide an estimated seventeen acres of new burial space. Because the current burial process is extremely efficient and important to families requesting disinterments, I urge the city

not to close Hart Island.

New York City began using common plots with 150 bodies laid out in a grid in 1872. This burial process was invented during the American Civil War to inter Union Soldiers within their regiments on battlefields such that they could later be removed and reinterred in National Cemeteries or private cemeteries. New York City adopted this burial process because sepulchre rights require the city to disinter and return remains to families and because New York State prohibits cremation of unclaimed or unidentified human remains.

I am also advocating for keeping Hart Island open as an active cemetery because the burial process on Hart Island offers a sustainable, ecological alternative to private cremation which uses large amounts of fossil fuel and releases toxins such as mercury into the air. Hart Island is the largest and oldest natural burial facility in the nation. None of the private cemeteries in New York City offer natural burials. Private cemeteries cannot recycle titled graves sold to families long ago. By comparison, New York City has long recycled graves and there is no shortage of new space as well as recyclable burial space on Hart Island.

Although not perfect, Hart Island has improved over the last decade. Graves are now marked using GPS. Ledgers are transcribed into a digital database. Work to mitigate erosion has begun. Debris has been removed. Graveside visitation has been established.

I have accompanied families to gravesites going back to 1994. It truly helps families to reconcile the death of a loved one by visiting a grave. If the City Cemetery closes on Hart Island, my fear is that the graves of people whose families are low-income will once again become remote and inaccessible.

I cannot over-emphasize how important it is to communities to feel that their members are treated respectfully in death. People readily believe that their dead are discarded if they can't easily and affordably visit graves and gain access to information. Removing or redacting burial information makes people feel that their loved one disappeared. I have never once had a family member complain about their loved one being listed on-line. I have never had a mother complain about her name being listed in a burial ledger.

The mother of an infant that was stillborn or lived five minutes wants to know exactly where her child is buried. She has the right to know. She has the right to name her child or not name her child. Every woman should be offered burial assistance as well as the right to decline burial assistance and agree to a city burial without feeling that her decision is shameful. For this reason, Hart Island burials should never be referred to as indigent burials.

Hart Island belongs to past and future generations of New Yorkers. This historic system of burials offers an ecological advantage. There is no good reason to end burials Hart Island because New York City is not running out of burial space. The best way forward is for the city to remove derelict buildings and develop a master plan that includes recycling graves after twenty-five to fifty years of burial. Most importantly, this masterplan must be not be hidden. New York City's burial process must be fully transparent.

EXISTING BUILDINGS

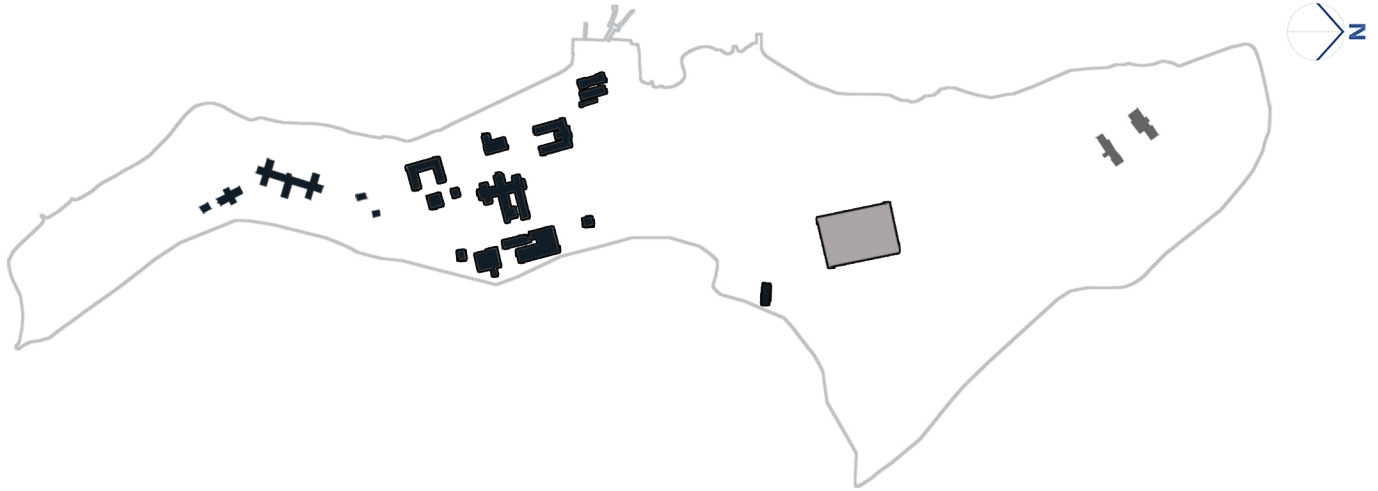

POTENTIAL BURIAL LOCATIONS

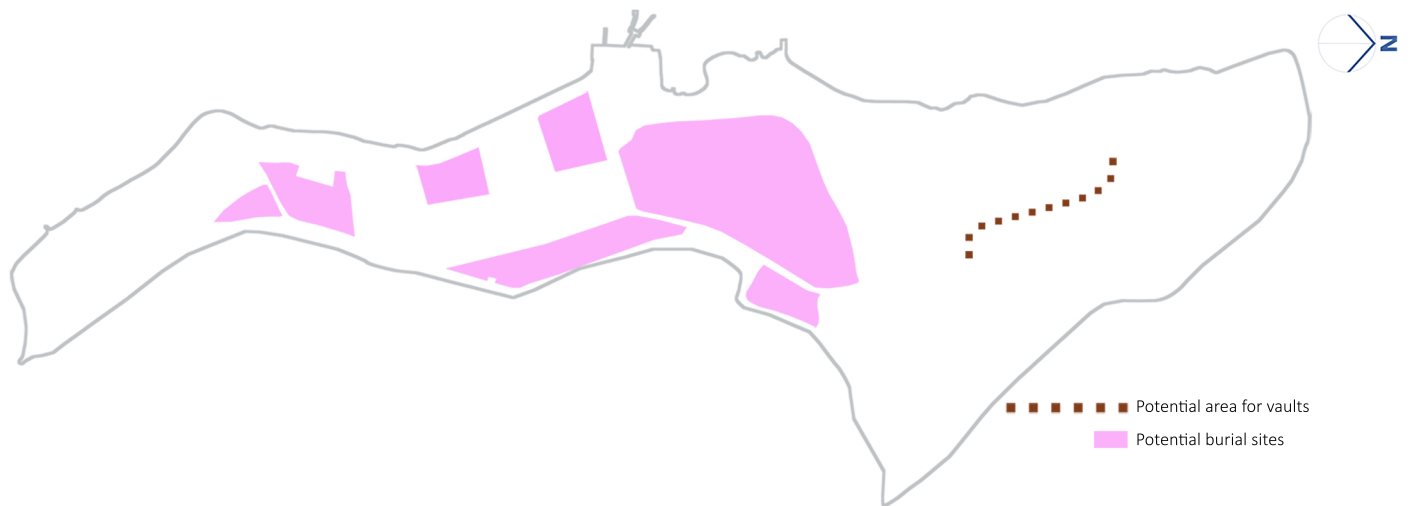

20% OF HART ISLAND IS AVAILABLE FOR NEW BURIALS

**HART ISLAND HAS APPROXIMATELY 80 YEARS OF CAPACITY
WITHOUT RECYCLING GRAVES**

Rick D. Chandler, P.E.
Commissioner

Timothy D. Lynch, P.E.
Assistant Commissioner for
Forensic Engineering
Concrete Unit
Local Law Units
timlynch@buildings.nyc.gov

280 Broadway – 4th Floor
New York, NY 10007
www.nyc.gov/buildings

+1 212 676-2858 tel

May 12, 2015

NYC Dept. of Buildings
Warner De Foe
Bronx, NY 11201

DRAFT

For use by DOB and Parks and
Recreation Department only.

Re: Hart Island, Condition survey of 20 buildings/structures.



Image 1. Aerial view of Hart Island. For building identification, see Image 2-4.

1.0 Summary

Unsafe conditions currently exist for the twenty historic structures on Hart Island that are accessible to the general public. Various ruined buildings are open, vacant and unguarded.

Hart Island is a one mile long by one quarter mile wide (131 acres) island laying northeast of City Island in the Bronx in the Pelham Islands group. The island is owned by the City of New York and access is controlled by the Department of Correction (DOC). NYC Council Bill #0848 introduced in 2012 would transfer island jurisdiction to the NYC Parks and Recreation Department (Parks). At the request of Parks, the DOB has assisted in performing an assessment of the 20 remnant buildings and structures on Hart Island. On April 14, 2015, the DOB (T. Lynch, C. Wolf, D. Spivack) accompanied Parks (J. Krawchuk, M. O’Hea Anderson) for a site inspection to determine structural conditions for public safety. Hart Island serves as the city’s potter’s filed (101 acres) with an internment of an estimated one million remains of individuals. Access to Hart Island was provided by the NYC Department of Transportation (DOT) ferry from the Fordham Street pier on City Island.

The recommendations for structures are as follows:

Action	Totals	Structure number
<ul style="list-style-type: none"> • Recommend for immediate repair: • Install fence, possible ruin site: • Immediate demo, backfill 	2 total 2 total 13 total	#10, 20 #15, 17 #5, 7abc, 8, 9, 11, 12, 13,14, 16, 18, 19
<ul style="list-style-type: none"> • No action required • Vegetation removal (Peace monument) • Remove rubble (doctor’s house) • Lower chimney • Fence installed by others (silos) 	1 total 1 total 1 total 1 total 2 total	#4 #1 #6 #7d #2, 3

2.0 History

Hart Island has historical cultural significance as a cemetery dating from 1863, a Civil War internment camp, a psychiatric institution, a sanatorium, a reformatory and a former Nike missile site. It is a natural island with no fill. (Source: www.hartisland.net/history)

Hart Island has no permanent population. Power is supplied by generator from the DOC compound which consists of three trailers. Potable water is pumped to the island by the city for use in hydrants. The public is allowed limited access on the island on the third Thursday of the month; the public is allowed visitation at the gazebo.

Rikers Island inmates currently perform burial details for approximately fifty remains of individuals per week. At this rate, DOC estimates the island has designated open land for burials to last another decade. The NYC Office of Chief Medical Examiner takes custody of unclaimed or unidentified remains and after approximately thirty days will designate interment on Hart Island. If remains are subsequently identified, or if a family claims remains, the remains will be disinterred for private burial.



4.0 Observations

Access to the island is by ferry to docks in acceptable conditions. There are limited facilities on the island which are located in the compound for DOC staff and prison staff. On days when the public is invited for events, the public is instructed to remain at the gazebo location, however there is no fence or permanent signage to mandate public compliance.

Most buildings/structures are vacant, open and unguarded. This poses a security risk to public safety. Foliage is in an over-grown condition and also poses a safety risk. There is inadequate signage which poses a significant public safety risk.

The DOC compound consists of three trailers enclosed by fence. A generator supplies power to the island. DOB did not observe the compound.

The general public is allowed access to the gazebo and the docks which the DOB did not observe.

5.0 Recommendations:

5.1 Safe haven. The Records Building, #10, is recommended for immediate repair and can be put into service. This building is one story plus cellar. With a footprint of approximately 35 feet by 35 feet, this building is easy to restore.

5.2 Fencing. Fencing should be installed for a total of 2 buildings. This is to secure the vacant, open, and unguarded buildings. The federal government is currently in dialogue to install fencing around two missile silo sites.

5.3 Signage. Throughout Hart Island, permanent signage is recommended immediately. Signage to include: name of building, "no trespassing" at designated buildings/sites, "no trespassing" at designated days/times, and contact names and numbers. Unsafe buildings are to be designated as such.

5.4 Vegetation. Immediate tree/vegetation removal is recommended for the structures that will remain. Vegetation removal is also recommended for all areas as it conceals open pits and cellars. Significant damage has been caused by both weed trees and falling trees.

5.5 Masonry stabilization. Prior to boarding up designated structures and/or installing fences close to structures, all loose material must be removed from building/structures. **NO WORK TO BE DONE IN AREAS OF UNSTABLE STRUCTURES.** Note: The rate of decay for the 7 structures to remain is significant.

5.6 Street addresses. Establish street address, number, and proper names for all structures. Some structures are identified by several different names which leads to confusion.

Timothy D. Lynch, PE

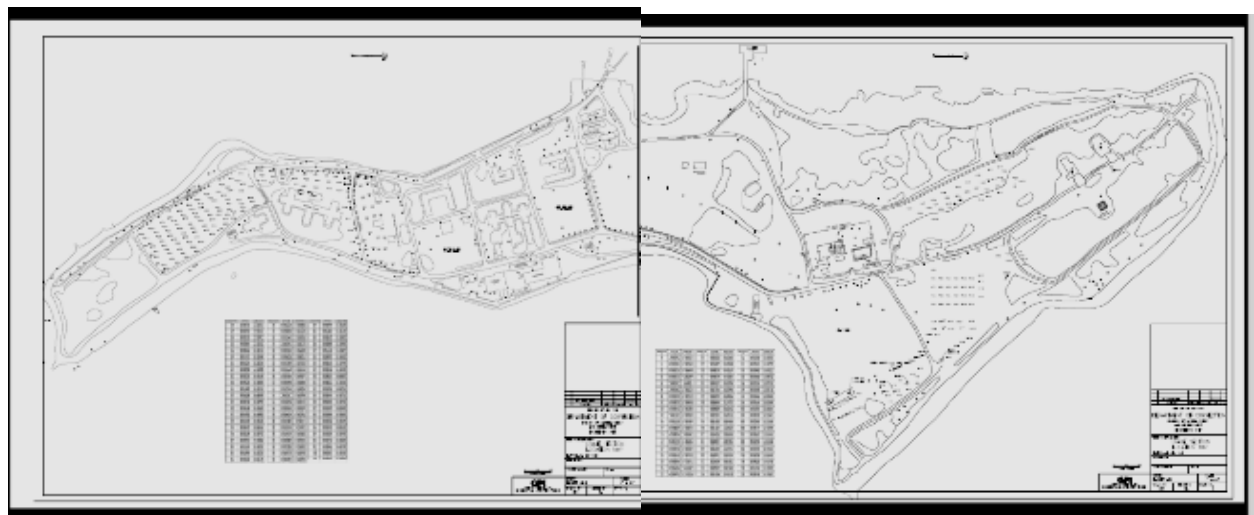
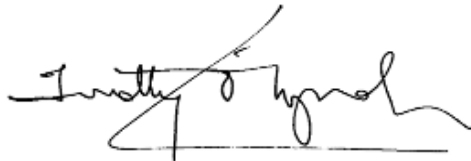

Image 2. DOC Location Map, 2010.

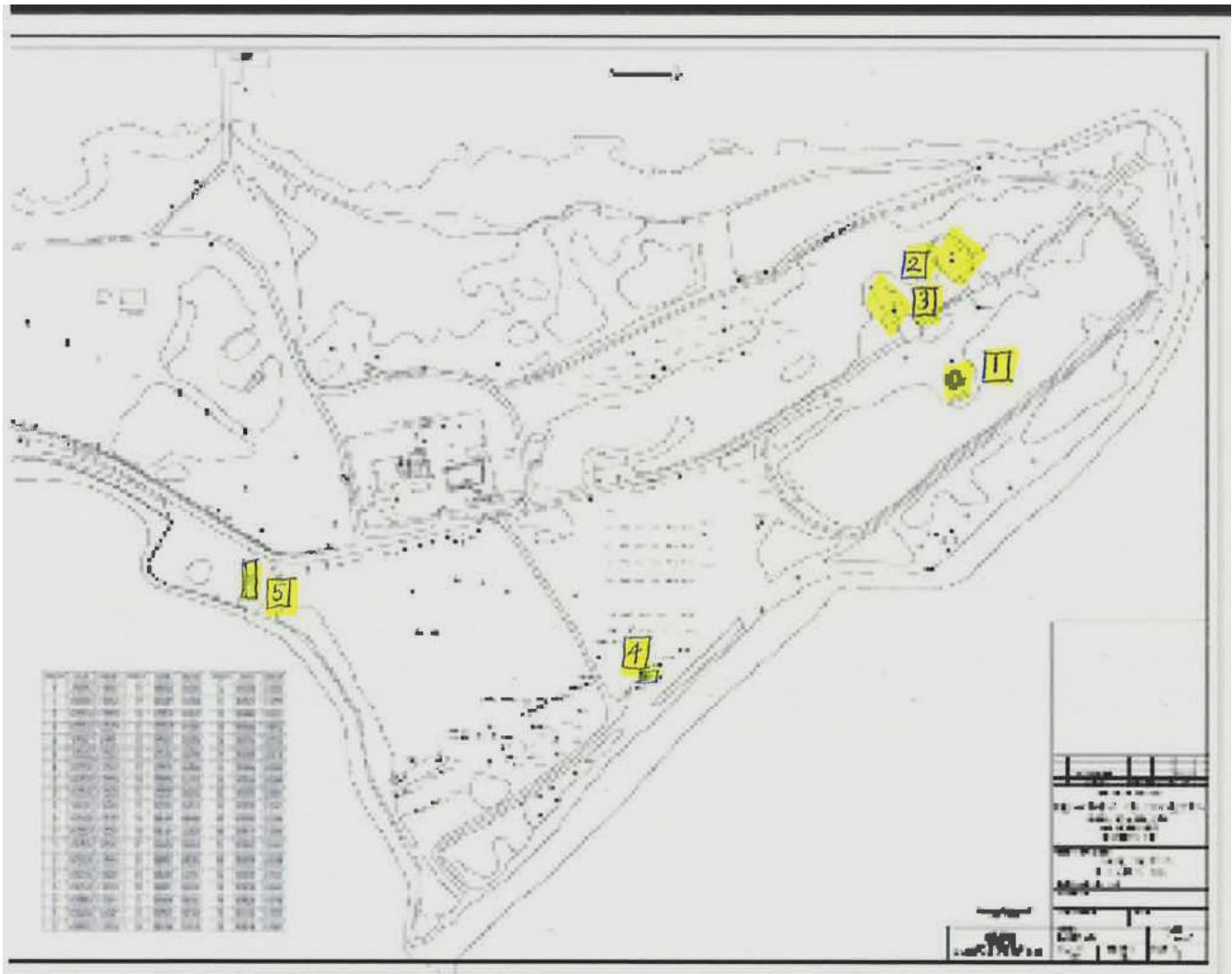

Image 3a. Detail of DOC Location Map, 2010, north section of island.
Buildings numbered from 1 to 5.



Image 3b. Detail of DOC Location Map, 2010, south section of island.
Buildings numbered from 6 to 20.

Building Number: 1
Building name: Peace Monument



Photo: 1a.

Description: Erected by prison labor after WWII. Constructed of reinforced concrete. Adjacent to earliest burial ground of Civil War soldiers who have been exhumed.

Date of construction: 1948

Assessable: -

Ease of restoration: None recommended.

Use: -

Recommendation: Remove vegetation.

Building Number: 2 and 3
Building name: Nike Missile Silos



Photo #2abcd (starting at upper left, clockwise for all photos.).

Description: Ruins of two missile silos owned by the federal government.
Date of construction: 1956
Assessable: Open and unguarded.
Ease of restoration: Stable.
Use: Anti-ballistic army base, Fort Slocum, 1956 - 1961.
Recommendation: None as the Army Corps of Engineers will install a fence soon.
Secure miscellaneous access openings. Photo 2c, 2d.

Building Number: 4
Building name: Pump House



Photo 4ab.

Description: One story small structure. Structurally stable.
Date of construction: -
Assessable: Door locked.
Ease of restoration: None.
Use: Possibly still in use.
Recommendation: No repair at this time.

Building Number: 5
Building name: Carriage House



Photo 5ab.

Description: Two story concrete block, steel beams, collapsed roof.
Date of construction: 1929 (MDCCCCX)
Assessable: Open, vacant and unguarded since 1962.
Ease of restoration: Poor.
Use: Former morgue.
Recommendation: High risk to public. Demo to grade.

Building Number: 6
Building name: Doctor's House



Photo 6a.

Description: Destroyed by fire, in ruin.
Date of construction: -
Assessable: -
Ease of restoration: Not feasible.
Use: -
Recommendation: Remove rubble.

Building Number: 7
Building name: Dynamo Room, Generator, Chimney, Taylor Shop



Dynamo Room



Taylor Shop



Dynamo Shop



Chimney



Chimney



Generator Building

Photo 7a-f.

Description: Three buildings plus chimney; Dynamo Room, Taylor Shop, Generator. All partially collapsed.

Date of construction: c. 1912

Assessable: Open, vacant, unguarded.

Ease of restoration: Not viable

Use: Utilitarian.

Recommendation: Demo three buildings.

Lower freestanding chimney by 20 feet and install fence around chimney safety zone.

Building number: 8
Building name Butcher Shop



Photo 8abcd.

Description: One
Date of construction: -
Assessable: Vacant, open and unguarded.
Ease of restoration: Not viable.
Use: Utilitarian.
Recommendation: Demo.

Building number: 9
Building name: Unidentified



Photo 9ab.

Description: One story brick in substantial decay.
Date of construction: -
Assessable: Vacant, open and unguarded.
Ease of restoration: Not viable.
Use: Utilitarian.
Recommendation: demo

Building Number: 10
Building name: Record Storage Building

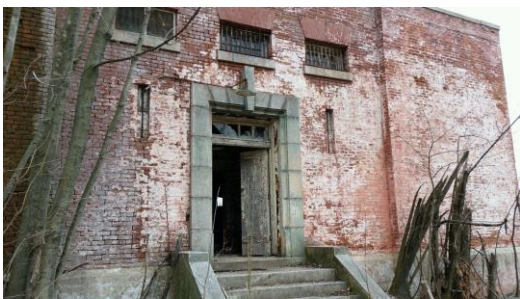

Photo 10 abcd.

Description: Structurally stable exterior walls and roof.
Date of construction: -
Assessable: Can be locked.
Ease of restoration: Good
Use: Document storage.
Recommendation: Best building to renovate immediately.

Building Number: 11
Building name: Miscellaneous Building north of Records Building



Photo 11a.

Description: Two story brick in unstable condition.
Date of construction: -
Assessable: Vacant, open and unguarded.
Ease of restoration: Structurally unstable.
Use: -
Recommendation: High risk to public. Demo.

Building Number: 12
Building Name: Miscellaneous



Photo 12a.

Description: Red brick with concrete base, flat roof.
Date of construction: -
Assessable: Vacant, open and unguarded.
Ease of restoration: Poor.
Use: -
Recommendation: Demo.

Building Number: 13
Building name: Staff house



Photo 13a.

Description: One story CMU in substantial decay.
Date of construction: -
Assessable: Vacant, open and unguarded.
Ease of restoration: Poor.
Use: -
Recommendation: High risk to public. Demo. Backfill and bring to grade.

Building Number: 14
Building name: Miscellaneous Building #14



Photo 14a.

Description: One story brick in substantial decay.
Date of construction: 1
Assessable: Vacant, open and unguarded.
Ease of restoration: High risk to public.
Use:
Proximity to roadway: Close to tour route.
Recommendation: Demo.

Building Number: 15
Building name: Pavilion (Shoe/Toy Factory)



Photo 15abc.

Description: Two and a half story brick with extension
Date of construction: 1885
Assessable: Vacant, open and unguarded.
Ease of restoration: High risk to public.
Use: Shoe and toy factory.
Recommendation: Install fence at safety zone. Allow to return to ruin.

Building Number: 16
Building name: Administration Building



Photo 16abcd.

Description: Three story red brick.
Date of construction: -
Assessable: Vacant, open and unguarded.
Ease of restoration: Poor.
Use: -
Recommendation: Demo.

Building Number: 17
Building name. Church



Photo 17a-d.

Description: One and a half story red brick.
Date of construction: -
Assessable: Vacant, open and unguarded.
Ease of restoration: Moderate.
Use: Religious.
Recommendation: Install fence at safety zone. Allow to return to ruin.

Building Number: 18
Building name: Phoenix House



Photo 18ab.

Description: Two story, red brick masonry with wood frame hip roof.
Date of construction: 1930s
Assessable: Open, vacant and unguarded.
Ease of restoration: Poor.
Use: Rehabilitation facility.
Recommendation: Demo, hazardous to public. A safety zone must be immediately established at perimeter of entire building; burial work is being performed in proximity to building that has loose masonry and loose roofing material.

Building Number: 19
Building name: Miscellaneous Building



Photo 19ab.

Description: Red brick in substantial decay.
Date of construction: -
Assessable: Vacant, open and unguarded.
Ease of restoration: Not viable.
Use: -
Recommendation: Demo.

Building Number: 20
Building name: Pumping Station



Photo 20ab.

Description: One story red brick.
Date of construction: -
Assessable: Vacant, open and unguarded.
Ease of restoration: Viable for storage.
Use: Former pumping station. Currently used for storage.
Recommendation: Repair for storage use. Repair windows. Install door/locks.



Dedicated to chesed shel emet since 1888

125 Maiden Lane, Unit 5B, New York, NY 10038 | Phone: (212) 239-1662 | Fax: (212) 239-1981

Email: info@hebrewfreeburial.org | Web: www.hebrewfreeburial.org

October 23, 2019

Attn: Anna-Kay Blackwood
Director of Contracts
Department of Social Services / Human Resources Administration
150 Greenwich Street
New York, NY 10007

Hebrew Free Burial Association (HFBA), founded in 1888, was organized to provide traditional, respectful Jewish funerals and burials to the indigent in our faith community. Since our founding 131 year ago, HFBA has continually owned and operated cemeteries in New York City. We have buried over 65,000 people. We are the largest Jewish indigent funeral service provider outside of Israel.

Our active cemetery on Staten Island, Mount Richmond, is accessible by public transportation; there is a direct bus route to our cemetery, located at 420 Clarke Avenue – the S74 bus from the St. George Staten Island Ferry Terminal. Our cemetery is open to visitors Sunday through Thursday, 9am-3:45 pm, 9 am-1 pm on Friday. We are closed only on the Jewish Sabbath and Jewish holidays.

HFBA partners with a not for profit funeral home, Capitol Funeral Service of New York (Capitol). Working with Capitol, we provide all the necessary funeral and burial services, included but not limited to transportation, filings, funeral preparation, coffins, grave and grave opening. (Please see attached price list). We provide nearly 400 graveside funerals and burials each year; we have the capacity to provide up to 1000. Our burials are conducted six days a week, Sunday through Friday. We also provide disinterment services as needed.

Our graves in Mount Richmond Cemetery cost \$1500 and the grave opening/closing charge is \$650. Grave markers cost \$550, installed.

As we do at present, we will work with the City to identify those indigent and unclaimed who are of the Jewish faith.

Jews bury their dead in consecrated Jewish cemeteries, not in non-sectarian cemeteries. Traditional Jewish burials are in essence 'green' burials as we do not embalm or cremate (both practices are against Jewish funeral beliefs). We dress our dead in cotton shrouds and bury them in plain pine coffins that contain no metal.

HFBA is willing and morally and ethically obligated to take care of all Jewish indigents, so that that each can receive the dignity that is mandated by our religion for the dead.

Respectfully submitted,
Amy Koplow
Executive Director

ARGUMENTS FOR MAINTAINING BURIALS ON HART ISLAND

ANN SHARROCK

44 Derby Road, Heaton Moor, Stockport, SK4 4NE, UK – ann@annsharrock.com

I am a British Landscape Architect and have come over to the US for this presentation as I have a particular interest in cemeteries especially in Hart Island. Since completing my Bachelor of Landscape Architecture 10 years ago I have specialised in developing natural burial sites and have prepared cemetery strategies for Hounslow (London), and Bristol City, as well as concept and detailed designs all over the UK.

I have undertaken a number of feasibility studies to locate land for cemeteries and crematoria in the UK, a process that may be more challenging bearing in mind the difference in land availability between the US and the UK.

I have written a number of articles and given papers at national and international conferences on urban natural burial and have been interviewed on the BBC local and national radio. I am currently commissioned to design the Woodland Trust's flagship natural burial site near Buckingham, approximately 60 miles north of London.

I read an article in the UK national press in 2015 about the burial processes on Hart Island and since then I have visited New York twice, at my own expense, to work with the Hart Island Project and present burial and landscape strategies to Borough and City officials that would facilitate sustainable, dignified burials as well as create an interesting, dynamic biodiversity.

Trend of burials

There are between 1000-1200 burials per annum on Hart Island, that is approximately 19 to 23 burials per week. This is extraordinary and large scale by any standards.

The shortage of burial space within all major cities of the world is a problem. From South Bristol Cemetery, UK, to Green-Wood, New York, space is being culled from old paths and roads. Nearly every cemetery in New York City suffers from the problem of decreasing space for a number of dead that will continue to rise. (Source) The UK's Guardian in 2018 published an article entitled 'The Gentrification of death'. It cited the cost of a single grave plot in Green-Wood cemetery starting at \$19,000.

Devin Kelly concluded his article in the Guardian in July 2018: 'When burial space does finally, inevitably run out, the bodies of New Yorkers who are marginalised, poor and disenfranchised – or even simply not rich – will be the ones spending eternity somewhere other than the city in which they lived. There will be no room for them. It will be a kind of gentrification of the dead.'

New York City doesn't have this problem. It has Hart Island.

For over 150 years Hart Island has served the City of New York as a vital component in its burial system. We now have the opportunity to maintain this service and provide it within the context of a diverse ecological and cultural context that can be enjoyed by all for many years to come.

It offers sustainable natural burials for New York City and is the only natural burial facility for the entire city of over eight million residents.

Natural burial sites are havens for wildlife.

They are not manicured. There are no grand tombs symbolising wealth and status.

They are a shared landscape for burial, trees, plants and wildlife that resonate with a wider set of beliefs, benefitting nature and the community.

Hart Island offers the citizens of New York City sustainable burials, and the opportunity to create a flag ship natural burial site in a unique, distinctive landscape that is loaded with a cultural significance and accessible both physically and economically to New York City citizens, including those low income families that are unable to afford the cost of transport and burial or cremation to out of city cemeteries.

The nearest natural burial hybrid cemetery is in Sleepy Hollow in Westchester County. Even if City burials were feasible in Westchester County, they would be inaccessible to many New Yorkers who do not own cars and cannot afford transportation outside of the five boroughs. Hart Island is accessible to all communities for the cost of \$2.75.

The land still available on Hart Island supports the city's demand without the need to find additional burial space. Whilst cremation and other newer processes such as composting offer less land intensive options, for legal reasons, these are not options for those who chose a city burial or those who are unclaimed or unidentified.

The significance and importance of cemeteries for New York City residents extends beyond the proper disposal of the dead and embraces citizen choice, cultural, historical and environmental issues.

Sustainability

	Acres	Years capacity
Total new burial space available	17.7	
Approximate number new graves @ 5478 per acre	96,960 total new burials	80

Notes:

The figure given for the number of graves for one acre does not take account of pedestrian and vehicular paths and roads or retained woodland. In addition, the footprints of the buildings could be used to shape new plots and landscape elements and this may result in some loss of burial space, but the landscape will carry forward the history of the island.

The areas selected as available for new burials are indicated on the plan.

Summary:

Hart Island offers New York City 80 years new burial capacity without recycling existing graves. In addition, it could provide sustainable burial without the need to 'lift and deepen' or remove existing remains, if a system of recycling these new graves was planned.

Government planning policies and decisions strive to maximise choice for its residents, enhance the community infrastructure providing for their needs locally and make effective use of land. The continuation of burials on Hart Island fulfils all of these objectives.

Burials have taken place on Hart Island since the Civil War and there is a resonance between the people buried there and the history of the United States of America. Hart Island offers a large scale burial facility on land already owned by New York City and long used for this purpose and has the capacity to continue to remain as New York City's potter's field in perpetuity.

BURIAL AND CULTURAL AND HISTORICAL RESONANCE

The Department of Buildings determined that the buildings are unstable and should be demolished. If these buildings are removed, the resulting new burial space warrants keeping the cemetery open another 80 years without the need to recycle older plots. State law prohibits burials in rubble or ruins, but the footprints of the buildings could be used to shape new plots and landscape elements so that the history of the island is carried forward into the design for City Cemetery.

Under New York State sepulchre law immediate relatives may ask for the bodies of their loved ones to be returned. This legal requirement means that the city has to be able to locate unclaimed remains. The current practice of burying everybody in common graves means that the graves are opened around 85 times per year. This practice means that trees cannot be planted which help to stabilize the soil and prevent erosion. An alternative process for bodies where the families have not consented to a city burial is to place them in a structured vault built for this purpose so that they may be easily returned to the family.

Death and memorialisation relate to all cultures, classes and ages and whilst we memorialise death differently we all need space and an opportunity to remember. Hart Island presents those opportunities, which should be embraced with burial and landscape strategies that create dynamic woodlands, glades and meadows offering visitors a distinctive experience, with quiet places of contemplation and escape from the urban flow.

From: Cathy Cebek
Sent: Thursday, October 24, 2019 2:58 PM
To: EIS Contracts
Subject: Hart Island Hearing In burial process .

Hart Island should not become a public park . Intro bill 906 has no parameters , it only states the transfer from DOC to Parks . This could mean anything . No where in this bill does it state that it will not become a full access park open to the public , nor are there any restrictions for its use . A transportation study is not needed as only 24 people a month visit Hart Island . Unless the city is planning to open the island to all New Yorkers . Why would a study need to be done for 24 people a month traveling to Hart Island ? Why would council want to have ferries from Manhattan and Queens for 24 people that visit each month? I have been to two council hearings and have never heard about the amount of people that have visited . It is an average of 24 people a month . Since the last council meeting another weekend visiting day was scheduled . It was added quite easily , therefore just add more days for gravesite visits . This myth that it takes 6 months to a year to visit is just not true . You call to schedule a visit and ask for standby for the next visit . Each time I went there , only 8 people boarded the ferry even though the 50 spots available on the ferry were booked . No one needs a not for profit to negotiate visiting , it's available to those who wish to visit their loved ones. I have visited twice since the May 2019 hearing . You are escorted to the gravesite , but certainly not by armed guards as has been portrayed . We were told on our visit maybe ten years of burials are left , which did not include the land that are occupied by buildings . Those buildings are not salvageable , that space will add another 10 years of burial space , so in total that would be 20 years . There are 1000 to 1200 people buried there each year , half are babies and children . The rest of the city should follow how the borough of Staten Island bury the dead . No one goes to a potters field . We could do that at a far less expense and with much more respect and dignity .

The only access to Hart Island right now is from City Island , through a narrow street with no parking or infrastructure to accommodate access to a public park . Our community is a summer destination location without the proper safety that is afforded other parts of NYC that are deemed as destinations. City Island has one way on and one way off . We are an island . The ability to reach our community with emergency services will be compromised further adding another type of destination location . Our civic association is opposed , our community board parks committee rejected their support . We have petitions and surveys from our community overwhelming opposed to a transfer to parks . Parks is underfunded to take on this task. The DOC has done well with overseeing the island. Do we really need ferries from Manhattan , Queens etc , if it's not going to be a public park and only 24 people visit a month ? As of now anyone can register to go . Religious groups have services there and different types of services can be accommodated . Let's not pass a bill with no parameters and then do the surveys , that is just backwards . No to a park with no plans . At the City Council Hearing those that proposed this bill stated , there is no plan . Slow down and address the burial needs, add more days to visit . Have public outreach to inform those how to visit and the options for burials. Please allow these souls to Rest In Peace with the dignity and respect deserved to all.

Regards,

City Island Resident

Sent from my iPhone

My name is Kathleen Maher and I support City Cemetery staying open. I'm here to tell you my reasons why.

For nearly two decades, I surreptitiously eyed homeless people on the NYC streets, hoping one of them was my missing, twin-brother Kenny.

In 1991, at 20 years old, Ken flew from California to NYC. Although he suffered from a mental illness, he was functional. He was a gentle and free spirit who loved the ocean and bike riding in the hills that surrounded our home. When he arrived in NYC, he got a job in Queens but shortly after---*** he disappeared without a trace.

In 2007, I finally learned his fate. He died at St. Vincent Hospital from a trauma to the head after a fall on a street in Tribeca --**sixteen years before**. Because he died without ID, his body was buried on Hart Island as an unknown.

A week later, my brother Tom and I went to Hart Island for a "Closure Visit". We walked the island with a thoughtful guide and he pointed to an unmarked area where Kenny was buried.

It was not a place I would have chosen as his final resting place but it was surprisingly peaceful. Before we left the island, I found a rock that sits next to Kenny's photo at my home in Brooklyn. It was meaningful to finally be close to him after so many years and marked the beginning of an important grieving process.

A month later, on the lake we grew up on in California, a hundred family and friends gathered to remember and finally say goodbye to Kenny. It didn't matter that sixteen years had passed.

Later, the Medical Examiner's office informed me that Kenny had been disinterred, and per my request a Forensic Anthropologist examined his remains and discovered over half were missing. Even though they attempted to retrieve the rest- part of Kenny remains on the Island.

I will never forget sitting at the crematory, making physical contact with a plastic bag that contained his remains. It was a somber and necessary confirmation.

All of these difficult moments following the news of his death came with pain, anger and sadness. But they also provided welcomed relief from the agony of the years and years of not knowing if my brother was alive or dead.

These moments were possible because of the system that is in place today. Although the system is not without flaws, I hope others can continue to benefit by keeping Hart Island open.

Hart Island needs to continue to serve NYC for the following reasons:

1. When I worked as an oncology social worker, I met many families whose only option was city burial. It behooves us to provide a service that doesn't bankrupt families when a loved one dies. It is an important resource to financially vulnerable people.
2. Hart Island needs to exist in the five boroughs. Moving it outside NYC, decreases loved one's opportunity to grieve. Cost and time to travel outside of the city adds strain to an impoverished family. Moving it beyond the city sends a callous message: The dead are forgotten and do not matter.
3. The option for disinterment is **vital** for the grieving process, especially delayed grief. Kenny's cremains are finally resting in California with his name on a gravestone, close to family and his beloved mountains. Continuing disinterment sends a message: Grieving is important and matters.

I am a psychotherapist who, not surprisingly, specializes in loss and grief. Everyday I see the psychological and physiological damage when grieving is not possible. My own grief was complicated and delayed **but it was able to happen** and that made all the difference.

I'd like to thank Hart Island Project who took notice of our forgotten loved ones and continue to pay tribute to them in The Traveling Cloud Museum.

I hope my testimony gives those opposing Hart Island pause to think about the broader context of what it means to close it – there are thousands and thousands of stories just like mine!!

I urge every one of you to consider how critical it is to a healthy grieving process to be in close proximity of your loved ones, irrespective of your means. To eliminate it is a ghastly mistake for our city and our society.

In closing, a quote from Sir William Gladstone says it best:

*“Show me the manner in which a nation cares for its dead
and I will measure with mathematical exactness
the tender mercies of its people,
their respect for the laws of the land,
and their loyalty to high ideals.”*

Thank you.

Kathleen Maher
Brooklyn, NY 11201

Interest in providing testimony regarding Hart Island

Matthew Acer Class of 2019 New York Institute of Technology School of Architecture, NAAB Accredited University awarded Bachelor of Architecture Degree Spring 2019. Studio thesis: "Ritual. Place" Fall 2018-Spring 2019 (attached edited version of final thesis portfolio, midterm thesis portfolio containing research for this work can be provided). Site proposal for thesis culminated by looking at Hart Island. Studio Professor is Robert Cody, NYIT Director of Bachelor of Architecture Program.

My Thesis statement is relevant to the issues to be brought up at the public hearing regarding Public Burials on October 24, 2019.

My thesis statement presented in June 2019 was as follows:

Facing the rapidly approaching problem, cities high density finds it difficult to spare enough land for burials. The failure of the current model of cemetery has led us to move new burials locations outside city centers and outskirts of urban life. This displacement of cemeteries and ritual has created a disconnect of culture and memory. We need new typological approach to mediating between the dead and displacement. Would the introduction of the ideas of ritual space help dissect the issue? Can architecture intervene in this process?

As a unique and anonymous place of burial, Hart Island may provide NYC a unique place of ceremony in the time where limited burials can be made within city. In this proposal cremation is part of the ceremony and the potential for engagement with the islands landscape is under consideration. One scenario is to arrive to Hart Island by funerary boat for ceremony related to those to be buried or public ferry for engagement with nature related to potential public park space. For ceremony, the port of arrival marks the beginning of the ceremony. Multi-denominational rituals are prepared in a series of pavilions. The pavilions are formed and cited to respond to the time of day and consideration of the ceremony. Morning, afternoon, and evening pavilions with the effects of daylighting and night lighting develop a ceremonial ground that is made by the site. After the ceremonial pavilions is a potential place for crematorium. The plan takes shape further by thinking about the day, light, nature and our interaction with our elements related to these events and experiences in life in the city.

My midterm portfolio provides the research that brought me to my final drawings of which I am interested in sharing with the public as part of my testimony.

Ritual

Place

02 | Issue

Burial and Displacement

edited for this submission 10.16.19

Burial Architecture

Burial architecture is defined by the typology of the cemetery. The cemetery is defined as an area set apart for or containing graves, tombs, or funeral urns; especially, one that is not a churchyard. A cemetery is a burial ground which is located in a graveyard. The origin of the typology through language reveals the true meaning of the word cemetery; resting place.

What does it mean to be put to rest?

Can this rest be spiritual as well as physical?

Can the current typology of the cemetery house both types of rest within?

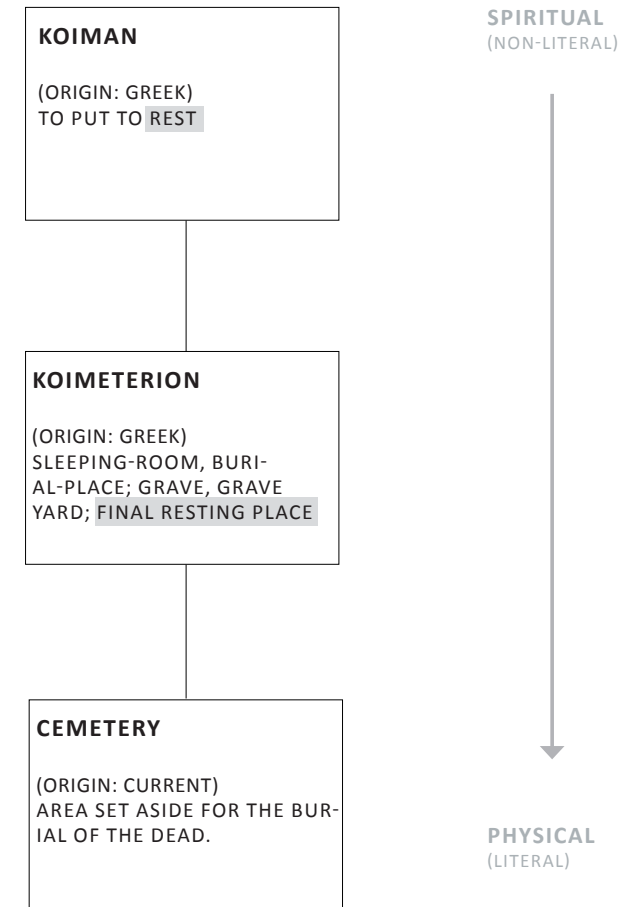

Physical Rest

Physical rest is defined by the physical placement of a body into a grave. the body is left in a single place and is not normally disturbed. this form of rest is the core issue behind the existing cemetery typologies today. the typical grave takes up space and is abandoned after a generation has passed. visitation is strictly limited to the burial site.

Spiritual Rest

Spiritual rest is defined by the rituals and actions that take place during the ceremony. these rituals put the body's spirit to rest and embed the body's memory into the place in which the ceremony is held. this definition of rest allows for the body then to be transported or buried elsewhere as the ceremony was the true moment of rest.



Ground (Singular)
Singular graves set side by side placed underground as not to be disturbed.



Ground (Multiple)
Multiple graves set into one pit also known as a mass grave.



Hung
Coffin enclosures are hung along side the side of a cliff.

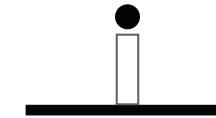

Sky
Bodies are left bare at the top of a ceremonial place to be picked apart by birds (the sky)



Cremation
Bodies are washed and burned into ashes. (Sometimes on pyres).

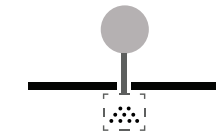

Environment
Body is cremated or placed in a biodegradable container to be used as fertilizer to grow nature.



Sea (Above)
Bodies are burned or left out to sea. Sometime this is depicted as a viking funeral.



Sea (Below)
Bodies are cremated and scattered across the sea or turned into a coral reef anchor.

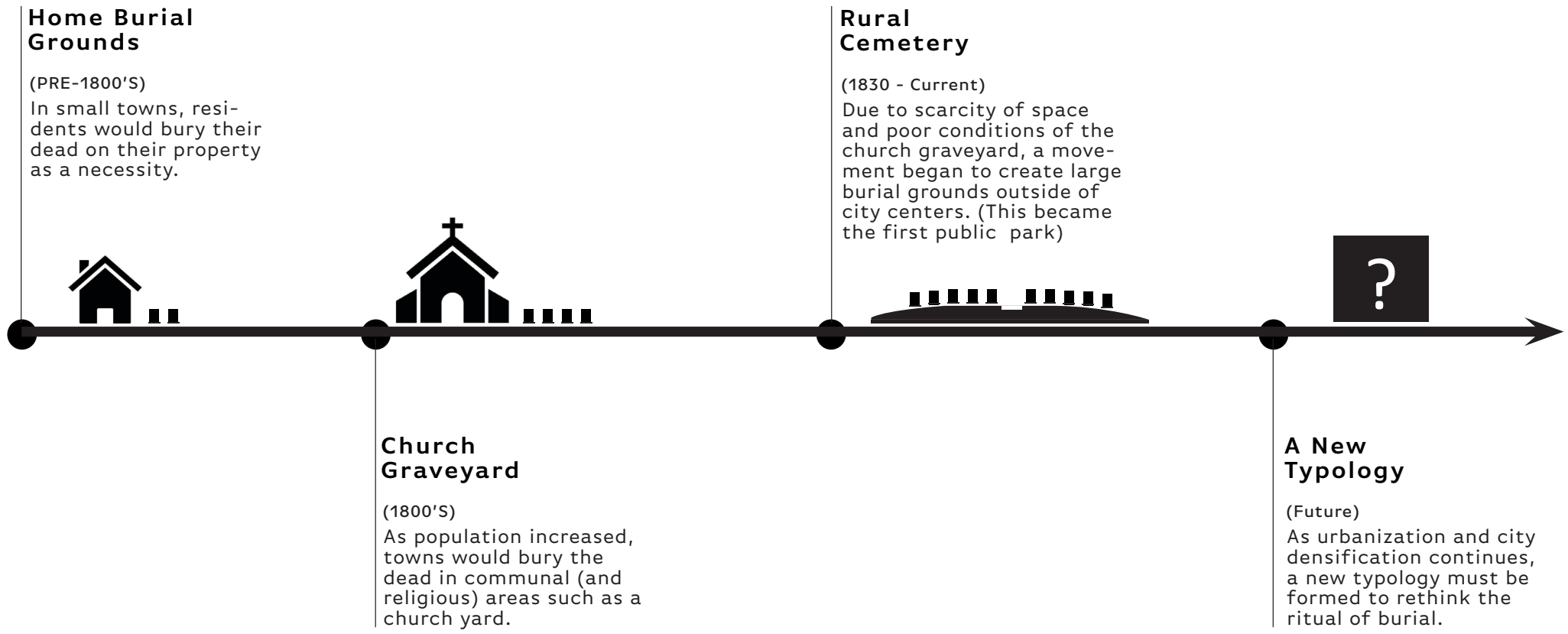

Thesis Statement

Facing the rapidly approaching problem, cities of high density find it difficult to spare enough land for burials. The failure of the current model of cemetery has led us to move new burial locations outside of city centers and to the outskirts of urban life. This displacement of cemeteries and ritual has created a disconnect of culture and memory. We are in need of a new typological approach to mediating between dead and displacement.

Would the introduction of the ideas of ritual space (and the device) help dissect the issue?

Can architecture intervene in this process?

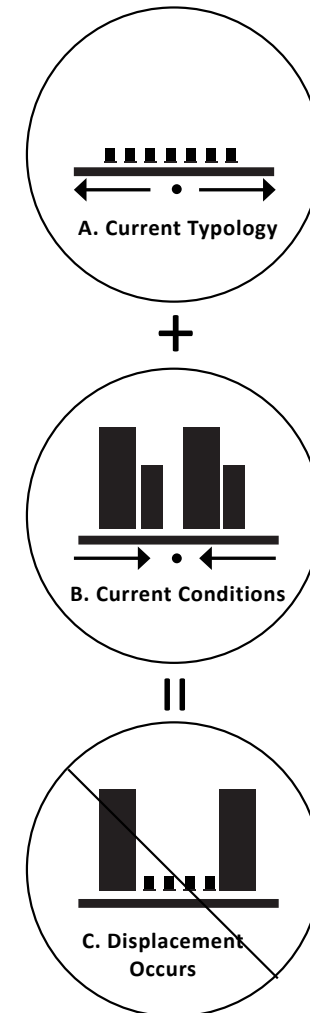

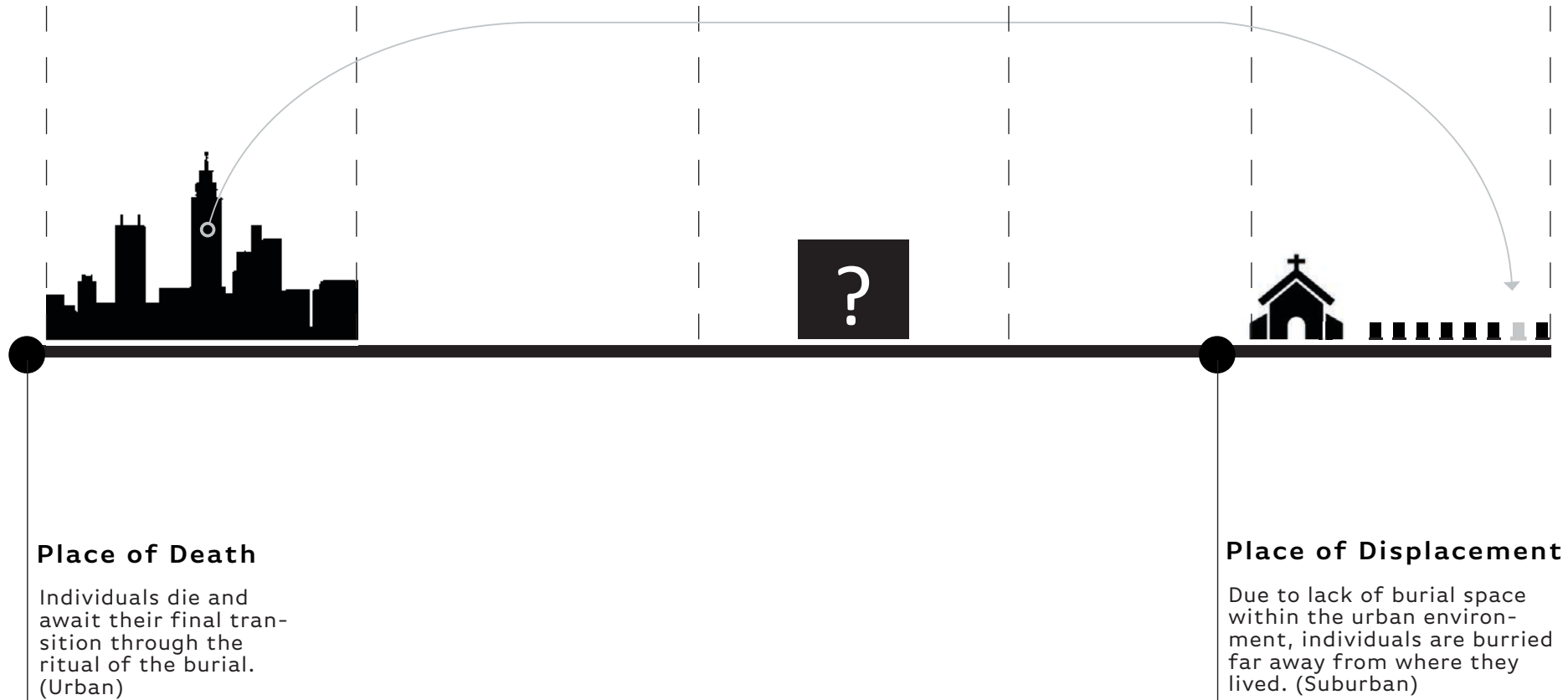

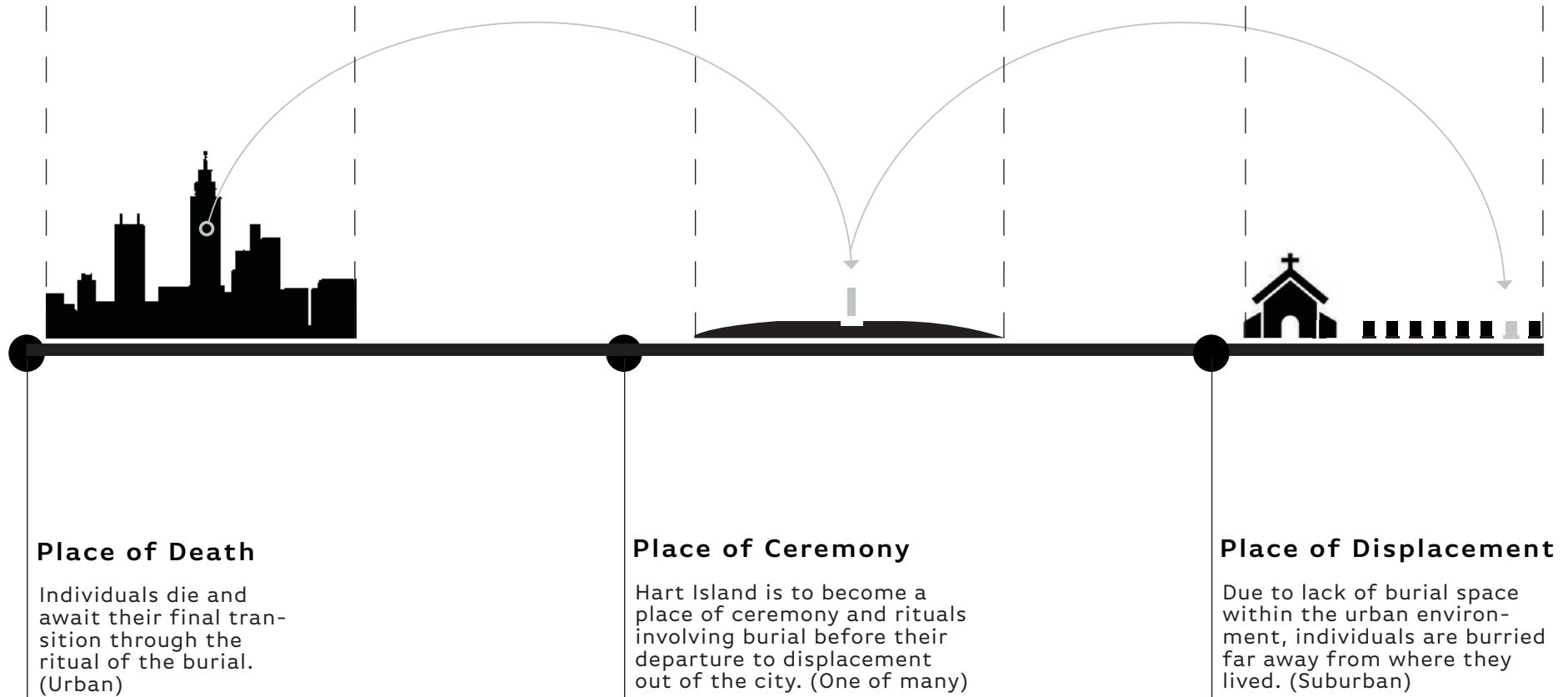



LEGEND

Inactive:

- 1. Pumping Station
- 2. Pheonix House
- 3. Chapel
- 4. Toy Factory
- 5. Butcher Shop
- 6. Tailor Shop
- 7. Generator
- 8. Admin. Building

Active:

- 9. Visiting House
- 10. Facilities
- 11. Civil War Monument
- 12. Peace Monument

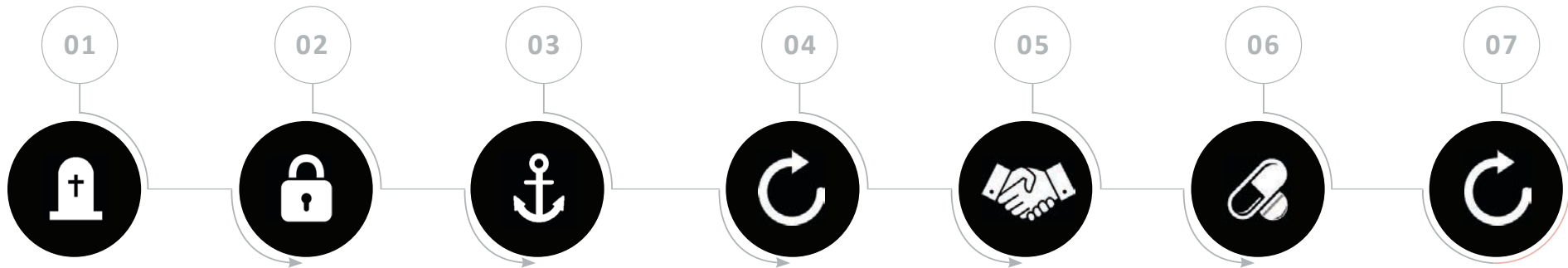

ESTABLISH

Hart Island was purchased by the City in 1868 from the Hunter family of the Bronx for \$75,000. The following year it was established as the City's public cemetery for the burial of those persons who died indigent or whose bodies went unclaimed.

ISOLATE

During a yellow fever epidemic in 1870, a part of the Island was used to house persons confined to isolation then in the later part of the 19th century the Island was home to a charity hospital for women, an insane asylum, and a jail for prisoners who worked on the Potter's Field burial detail.

OCCUPY

During WW II, the Island was turned over to the Navy for use as a disciplinary barracks for Navy, Coast Guard and Marine personnel. The closest WWII ever got to the shores of America came when three German soldiers surfaced in a U-Boat near Long Island. They were taken into custody and imprisoned for a time on Hart Island.

RETURN

Hart Island was returned to the Correction Department in 1946 and the jail was reactivated. In the 1940s, inmates on Hart Island appealed to the warden and offered to build a monument to the unburied dead. This was accomplished in 1948 when, in cooperation with the custodial staff, they erected a 30-foot high monument in the center of the burial site.

MIXED USE

From 1955 to 1961, the U.S. Army maintained a NIKÉ missile base on a ten-acre area of the Island. This continued mixed use of Hart Island showed its adaptability and usefulness in times of need.

REHABILITATE

In 1966, the jail was closed and the Island was used as a center for the Phoenix House narcotic rehabilitation program. This program was discontinued in 1976 and the Island returned to the Correction Department.

RETURN

The Department of corrections did not operate the Island as a jail until 1982, when a small prisoner contingent was again housed there. In 1991, the inmates housed on Hart Island were transferred to Rikers Island. (Burial duties have been assigned to prisoners every since)

03 | Approach

Idea of Intervention





Finding a Vernacular

The following diagram displays a dialogue of the natural and artificial elements of Hart Island over time. (As shown in previous images) The result shows how there is a natural separation of the two elements that will be further developed into an architectural approach for intervening into the island.

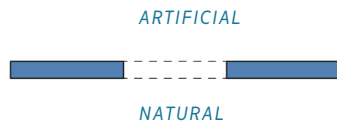

Finding a Vernacular

The following diagram displays a dialogue of the natural and artificial elements of Hart Island over time. (As shown in previous images) The result shows how there is a natural separation of the two elements that will be further developed into an architectural approach for intervening into the island.

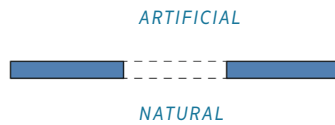

Finding a Vernacular

The following diagram displays a dialogue of the natural and artificial elements of Hart Island over time. (As shown in previous images) The result shows how there is a natural separation of the two elements that will be further developed into an architectural approach for intervening into the island.

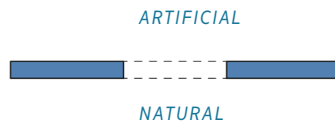

Finding a Vernacular

The following diagram displays a dialogue of the natural and artificial elements of Hart Island over time. (As shown in previous images) The result shows how there is a natural separation of the two elements that will be further developed into an architectural approach for intervening into the island.

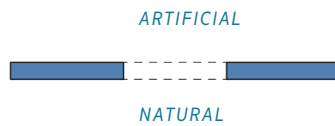

Language of Intervention

The following diagrams display a study and approach to developing a architectural language for the interventions on Hart Island. The tectonics are based off of the idea of dialogue of sky/ground and natural/artificial. (Similar to the ritual relationship of burial)

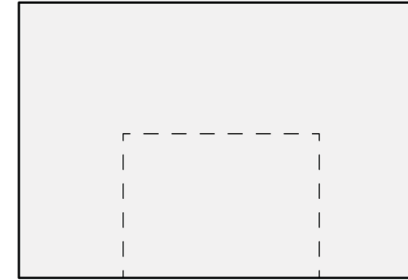
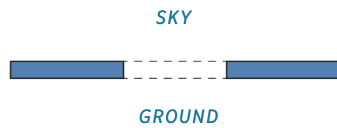

I. DEFINE

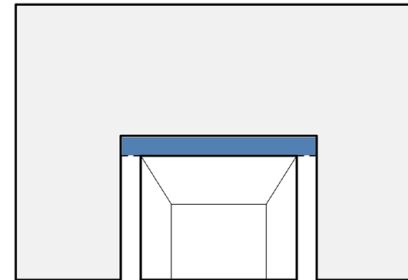

II. THRESHOLD

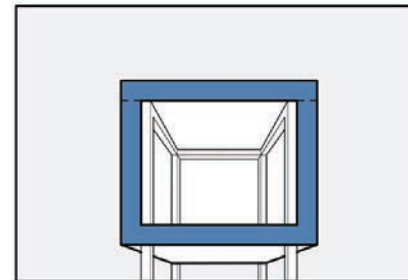

III. SUPPORT

Language of Intervention

The following diagrams display a study and approach to developing a architectural language for the interventions on Hart Island. The tectonics are based off of the idea of dialogue of sky/ground and natural/artificial. (Similar to the ritual relationship of burial)

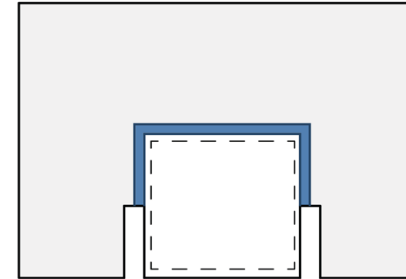
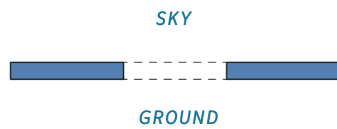

I. GROUND PLANE AS BASE

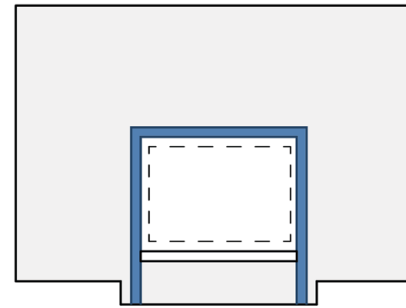

II. LIFTED GROUND PLANE

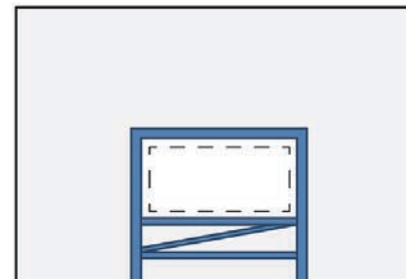

III. FULLY SUSPENDED

Language of Intervention

The following diagrams display a study and approach to developing a architectural language for the interventions on Hart Island. The tectonics are based off of the idea of dialogue of sky/ground and natural/artificial. (Similar to the ritual relationship of burial)

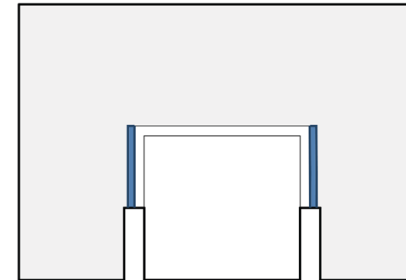
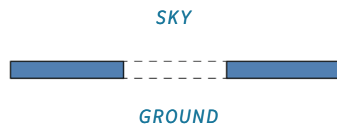

I. ENCLOSURE AS WRAP

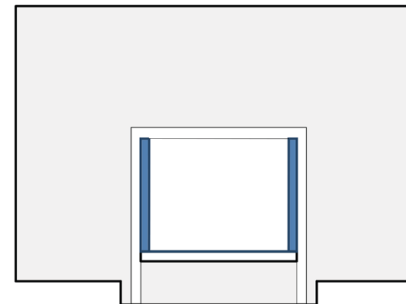

II. INTERIOR ENCLOSURE

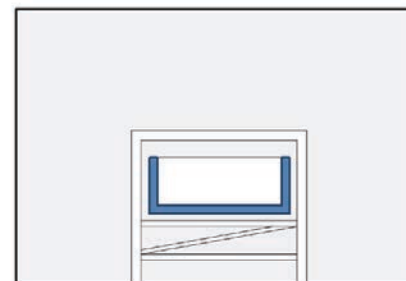

III. INTEGRATED

Language of Intervention

The following diagrams display a study and approach to developing a architectural language for the interventions on Hart Island. The tectonics are based off of the idea of dialogue of sky/ground and natural/artificial. (Similar to the ritual relationship of burial)

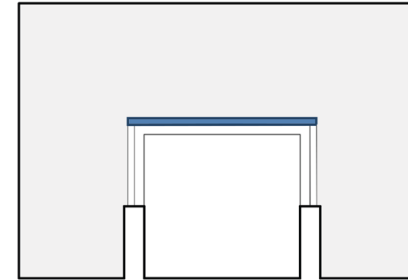
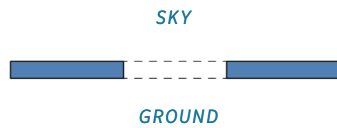

I. ROOF AS WRAP

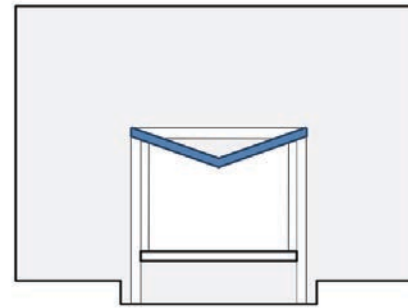

II. LIFTED ROOF



III. INTEGRATED ROOF

Light & Material

The following drawings display a study and approach to developing an approach to lighting the spaces within the ceremony halls. The light must be representative of the ritual (of day, of burial) and support previous dialogues.

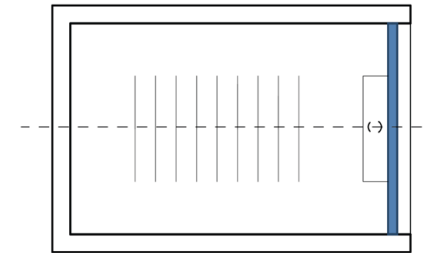
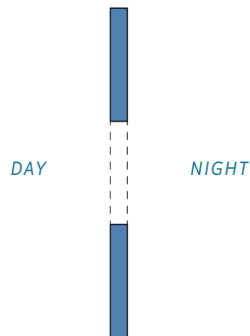

PLAN (NON-CENTRAL LAYOUT)

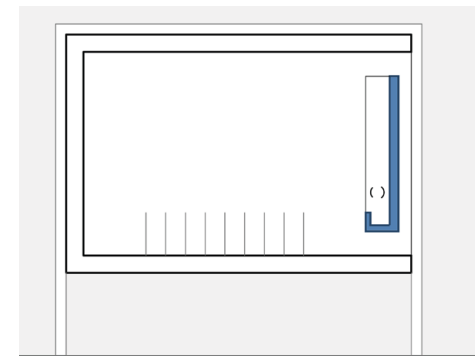

SECTION (NON-CENTRAL LAYOUT)

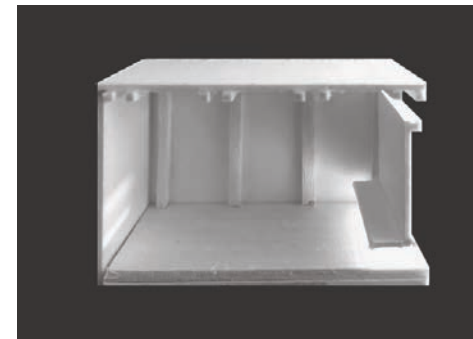

Light & Material

The following drawings display a study and approach to developing an approach to lighting the spaces within the ceremony halls. The light must be representative of the ritual (of day, of burial) and support previous dialogues.

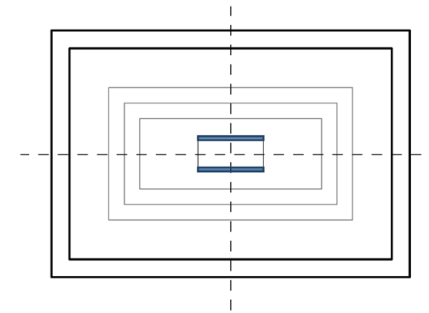
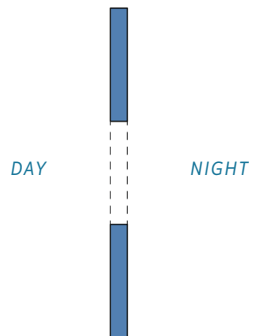

PLAN (CENTRAL LAYOUT)

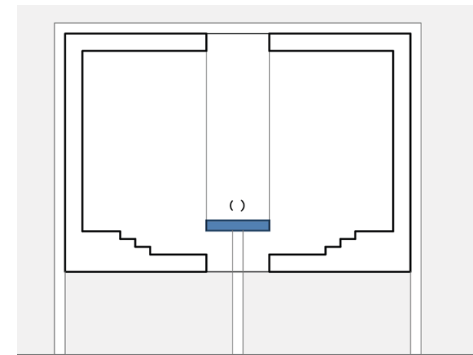

SECTION (CENTRAL LAYOUT)

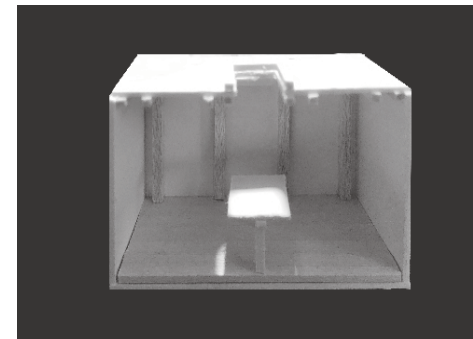

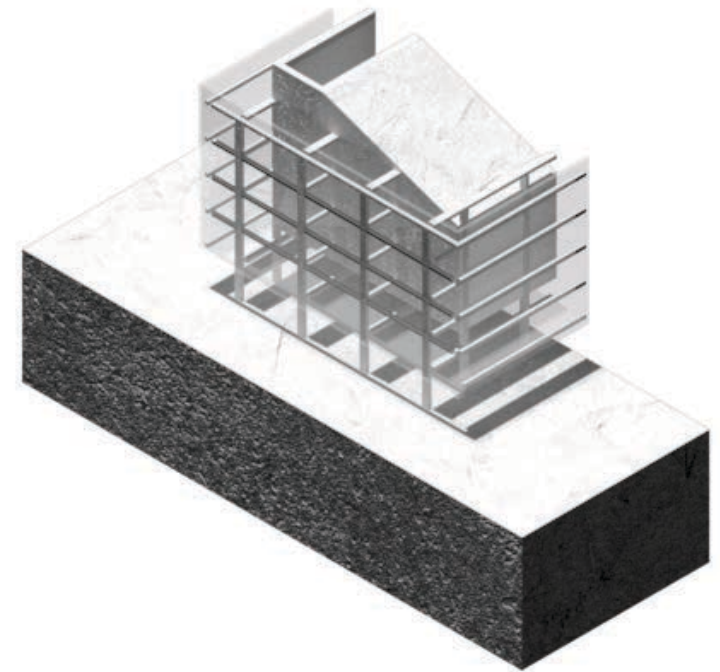
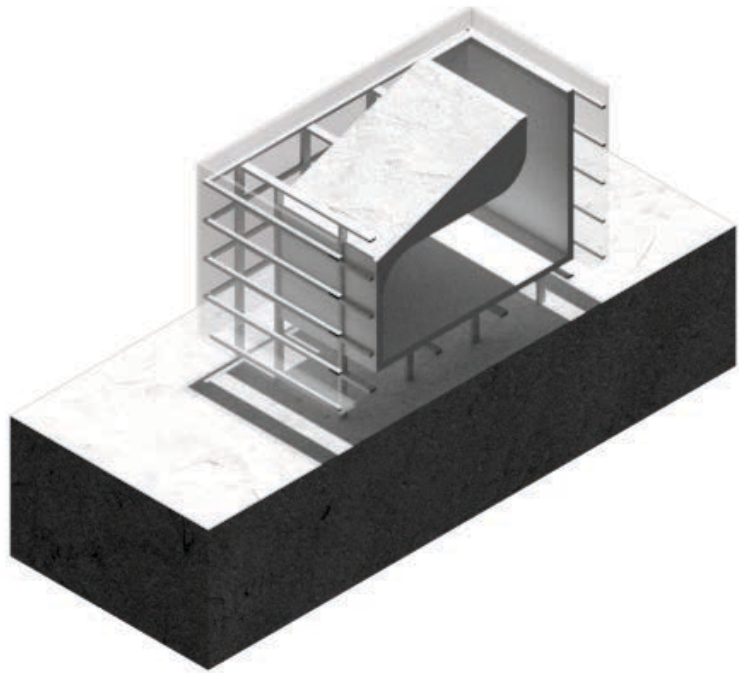

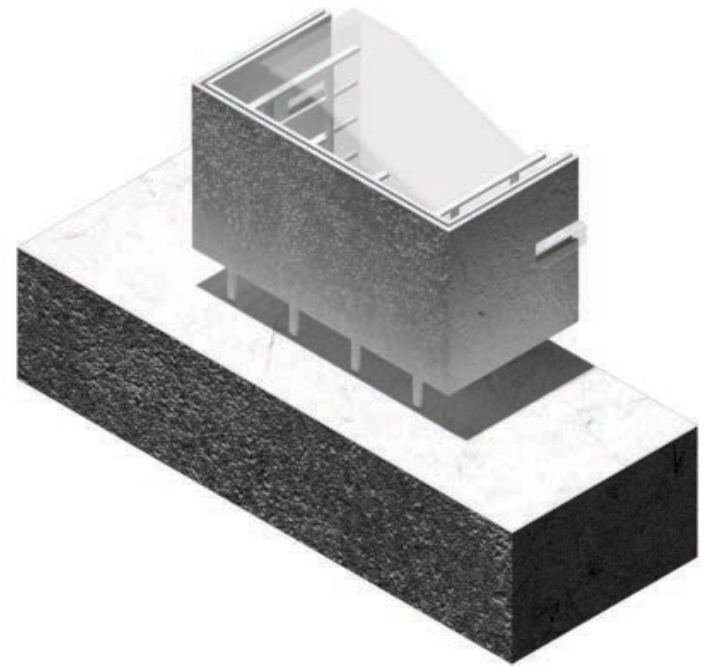
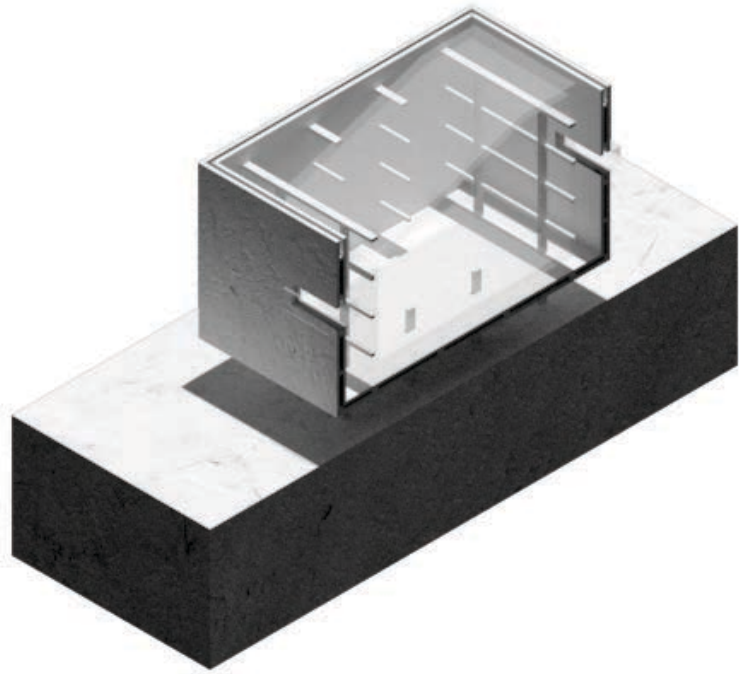

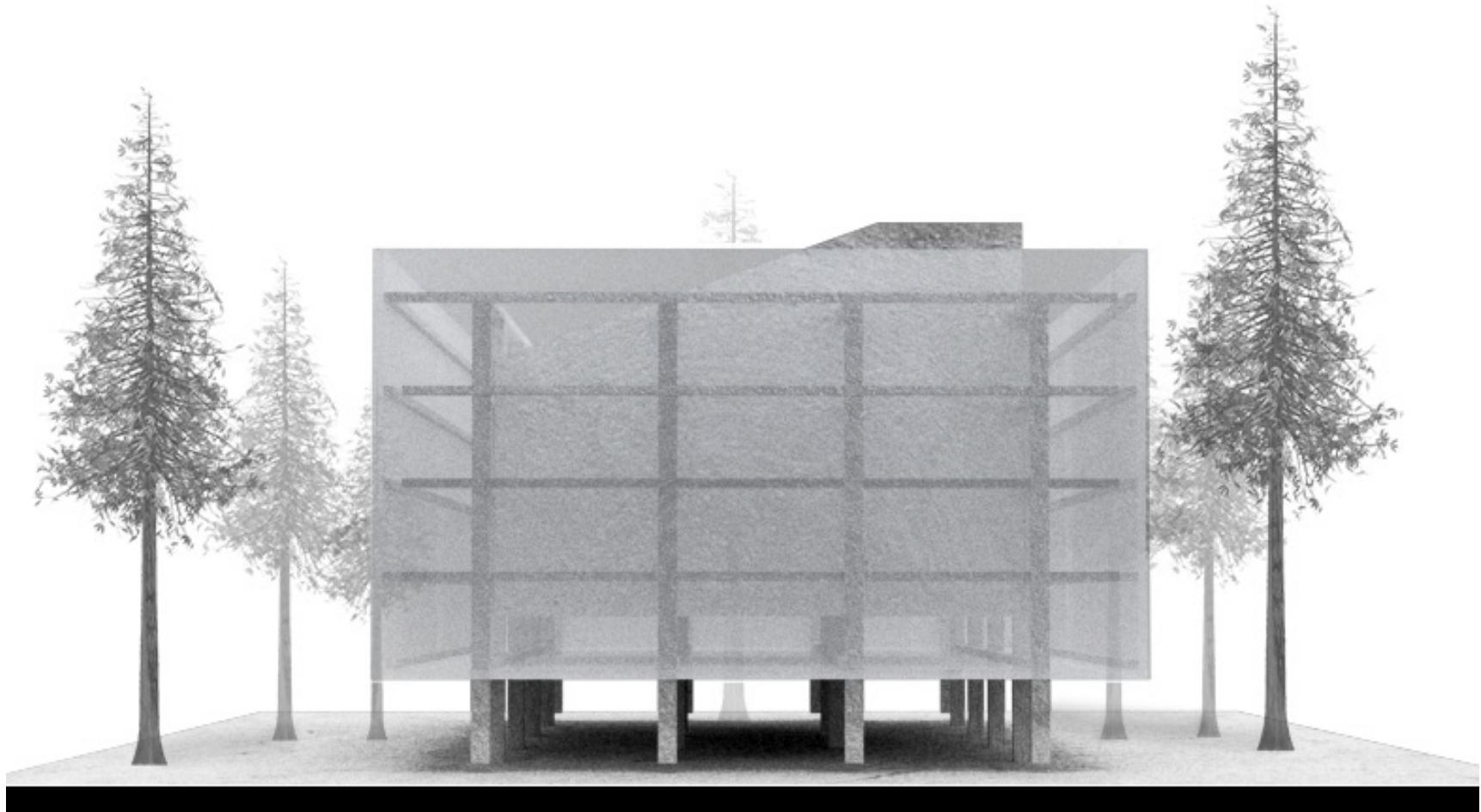

04 | Proposal

Prototype Intervention

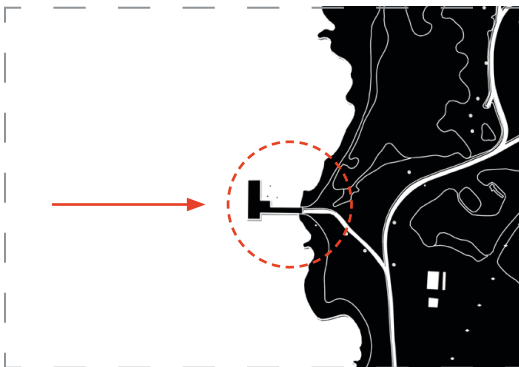

1. The Arrival

The Ceremony begins once visitors travel from City Island and arrive by water.



2. The Ceremony

A ceremonial procession occurs from arrival continues to a center point of the island where the funeral is held.
(Spiritual Rest - Memory embedded)

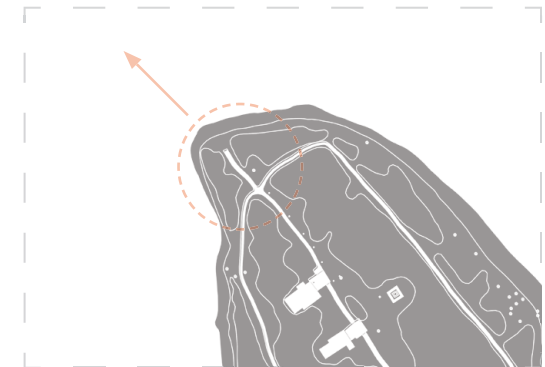

3. The Departure

A departure from the island marks the point of the ceremony where the body is then sent elsewhere for physical burial.
(Marking the last encounter)

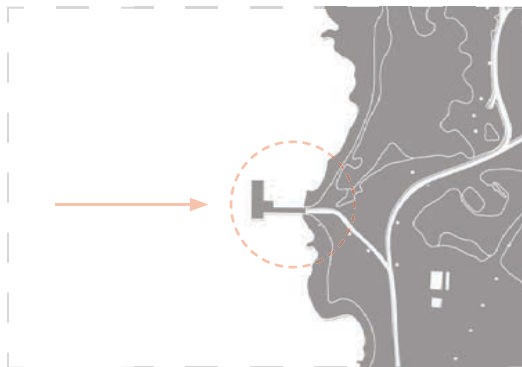

1. The Arrival

The Ceremony begins once visitors travel from City Island and arrive by water.

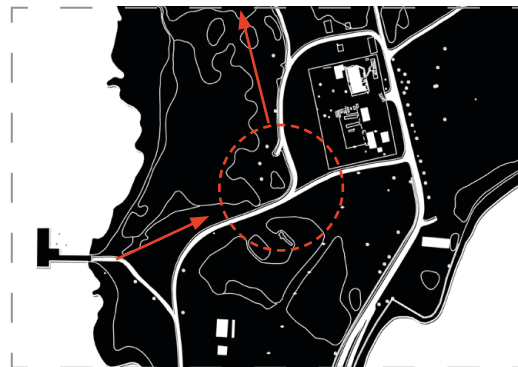

2. The Ceremony

A ceremonial procession occurs from arrival continues to a center point of the island where the funeral is held.
(Spiritual Rest - Memory embedded)

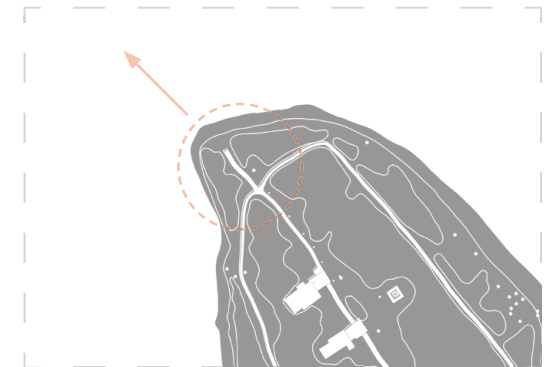

3. The Departure

A departure from the island marks the point of the ceremony where the body is then sent elsewhere for physical burial.
(Marking the last encounter)

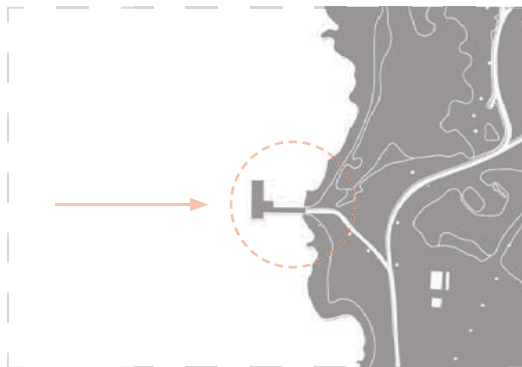

1. The Arrival

The Ceremony begins once visitors travel from City Island and arrive by water.



2. The Ceremony

A ceremonial procession occurs from arrival continues to a center point of the island where the funeral is held.
(Spiritual Rest - Memory embedded)

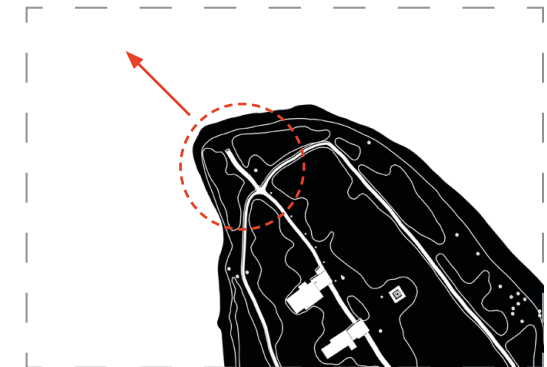

3. The Departure

A departure from the island marks the point of the ceremony where the body is then sent elsewhere for physical burial.
(Marking the last encounter)

04 | Design

Prototype Intervention



OVERALL MASTER PLAN - EXISTING
SCALE: NOT TO SCALE



ENLARGED MASTER PLAN - EXISTING
SCALE: NOT TO SCALE

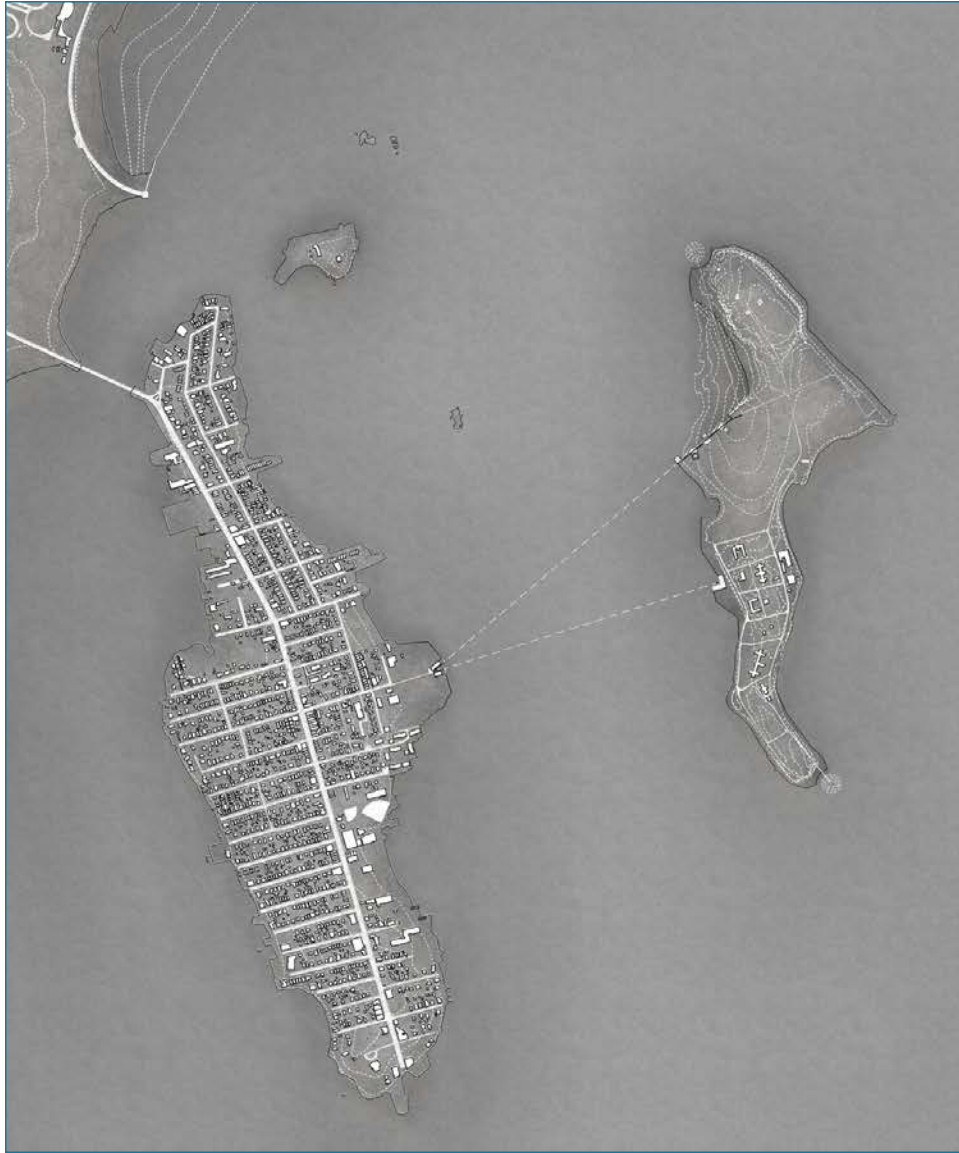

OVERALL MASTER PLAN - PROPOSED
SCALE: NOT TO SCALE

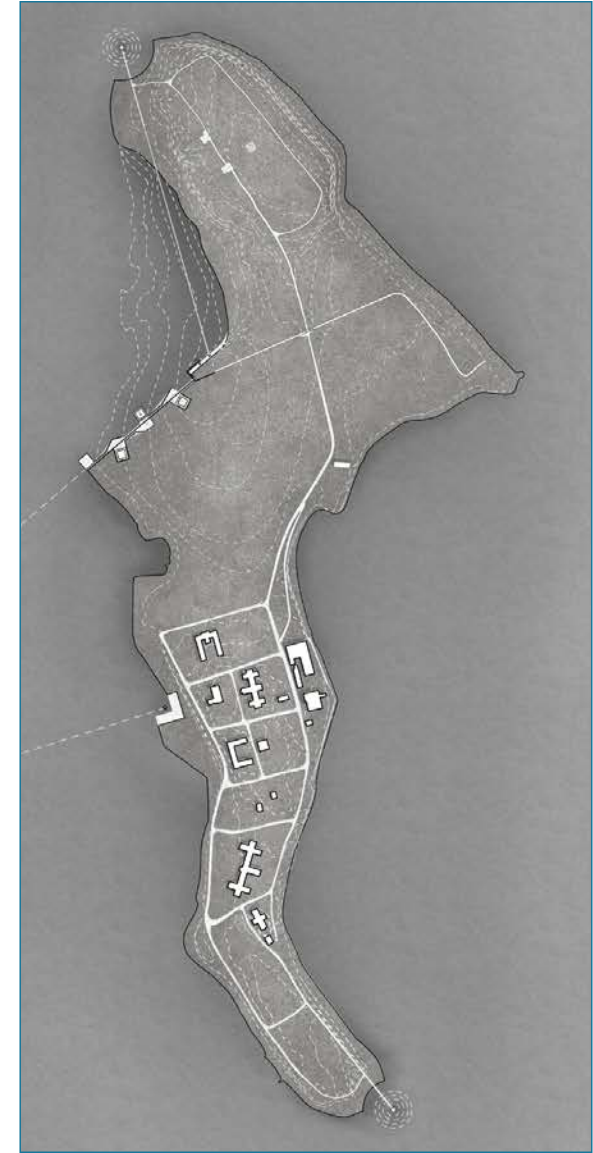

ENLARGED MASTER PLAN - PROPOSED
SCALE: NOT TO SCALE

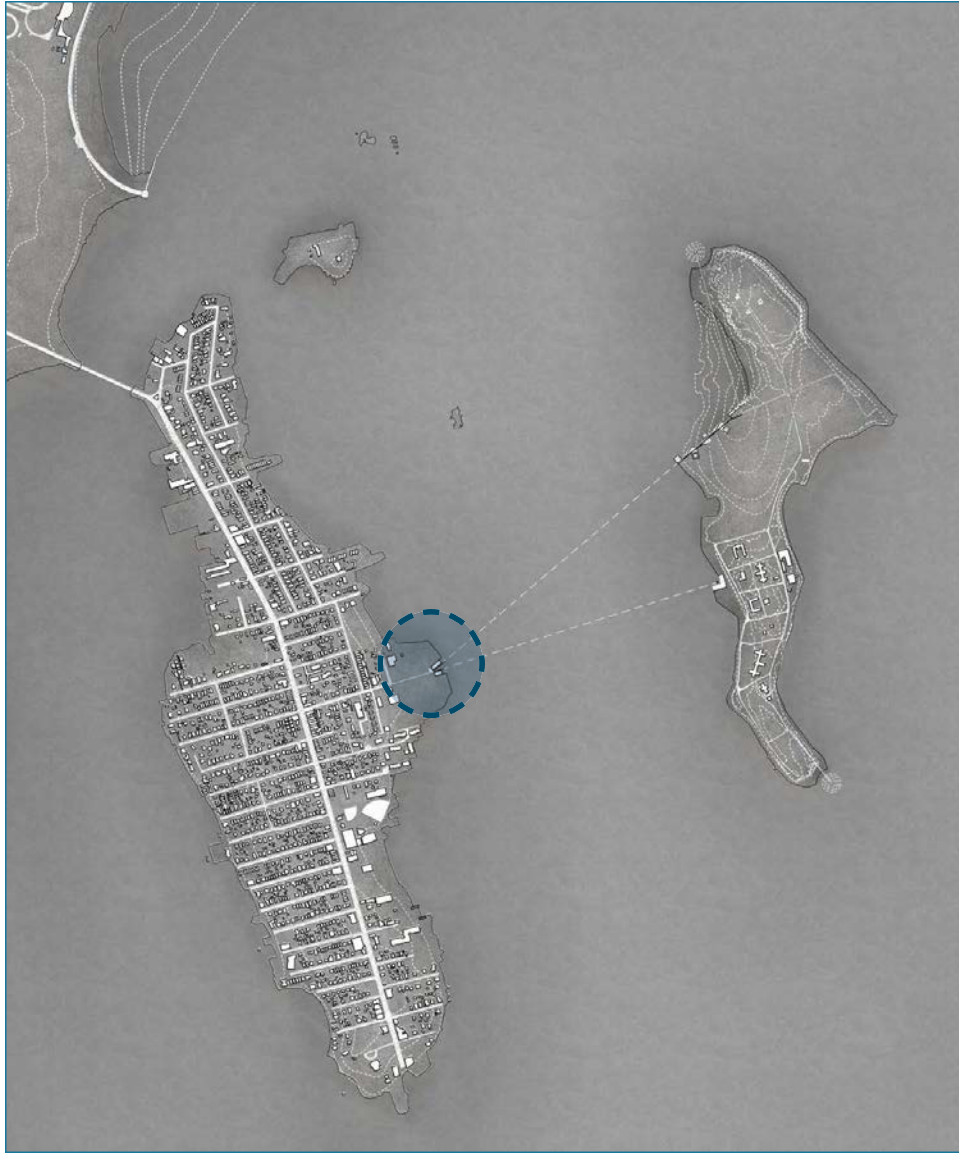

OVERALL MASTER PLAN - PROPOSED
SCALE: NOT TO SCALE

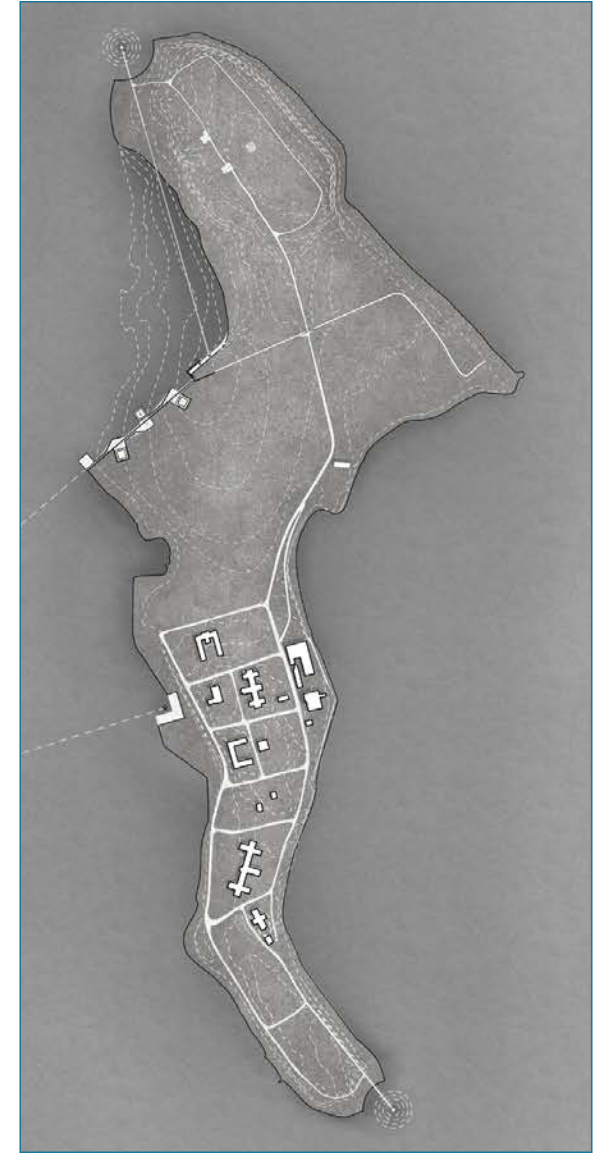

ENLARGED MASTER PLAN - PROPOSED
SCALE: NOT TO SCALE

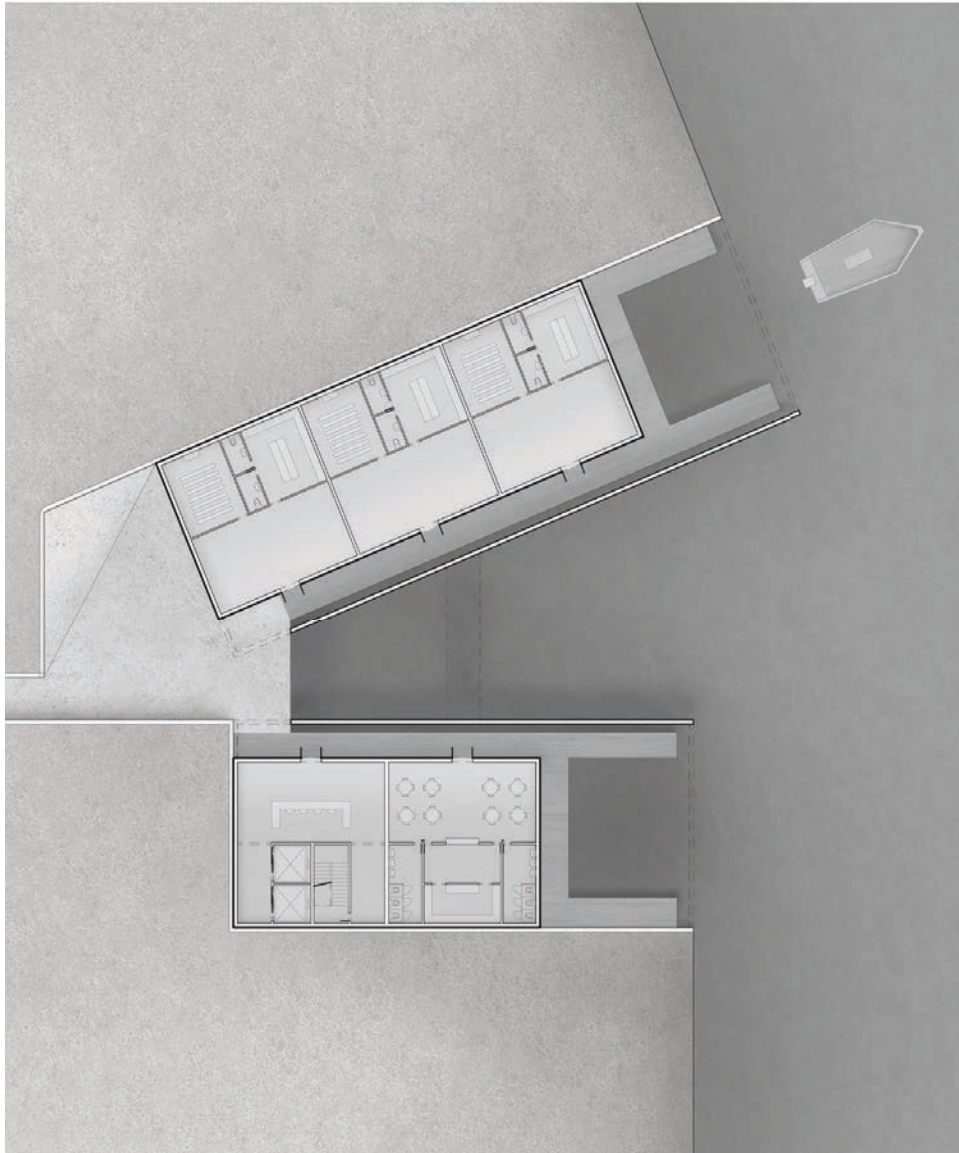

PORT CENTRE - FLOOR PLAN
SCALE: NOT TO SCALE

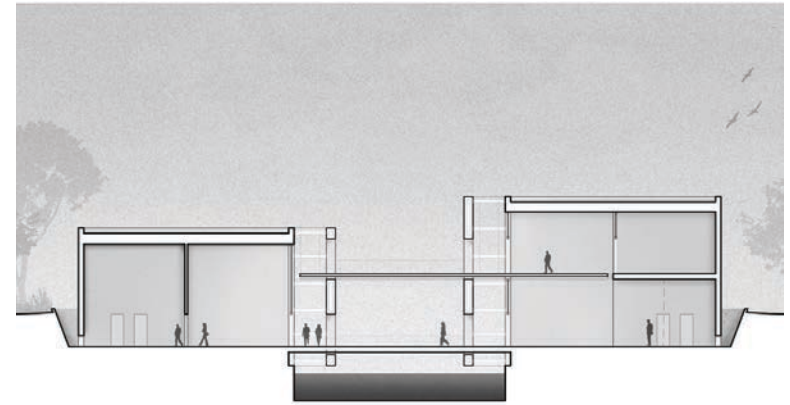

PORT CENTRE - SECTION I
SCALE: NOT TO SCALE



PORT CENTRE - SECTION II
SCALE: NOT TO SCALE

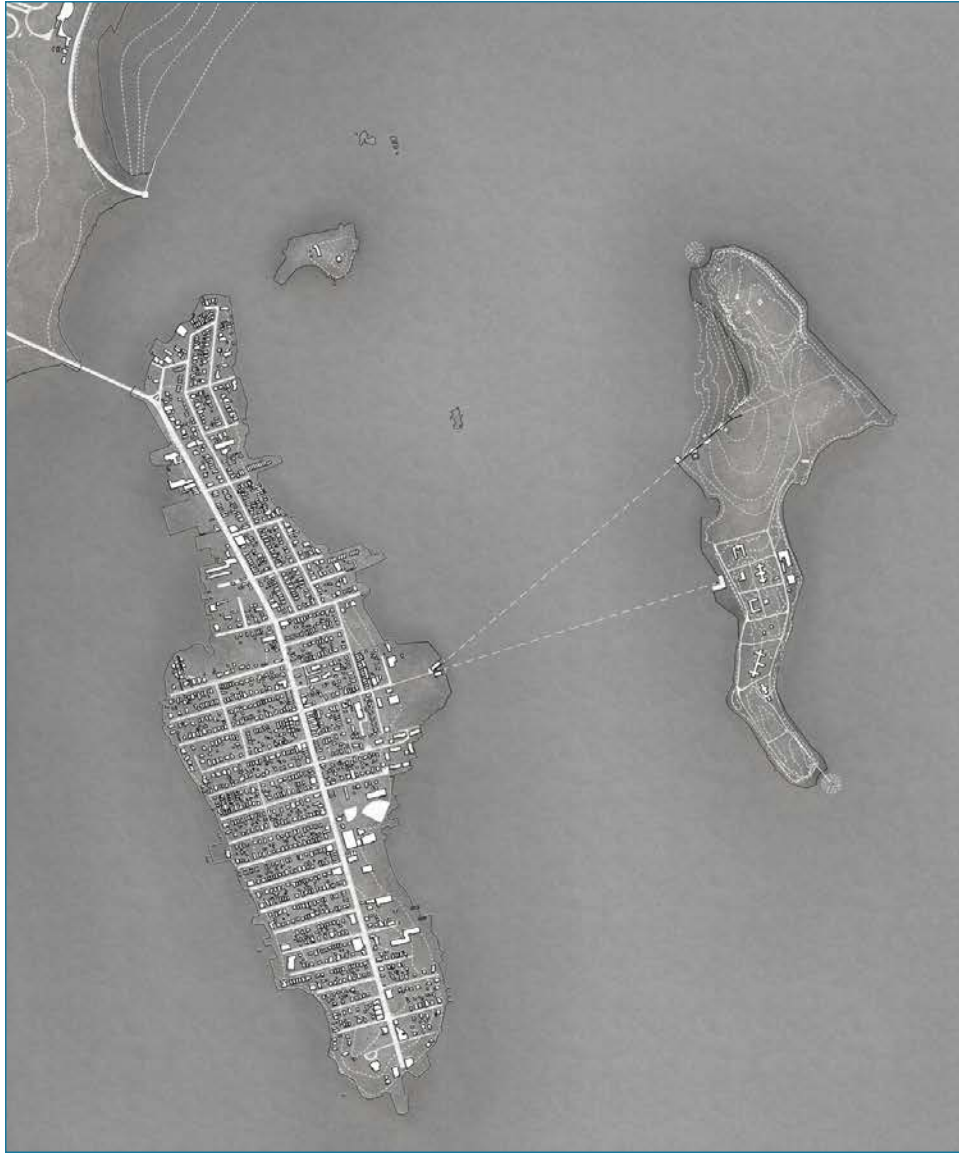

OVERALL MASTER PLAN - PROPOSED
SCALE: NOT TO SCALE

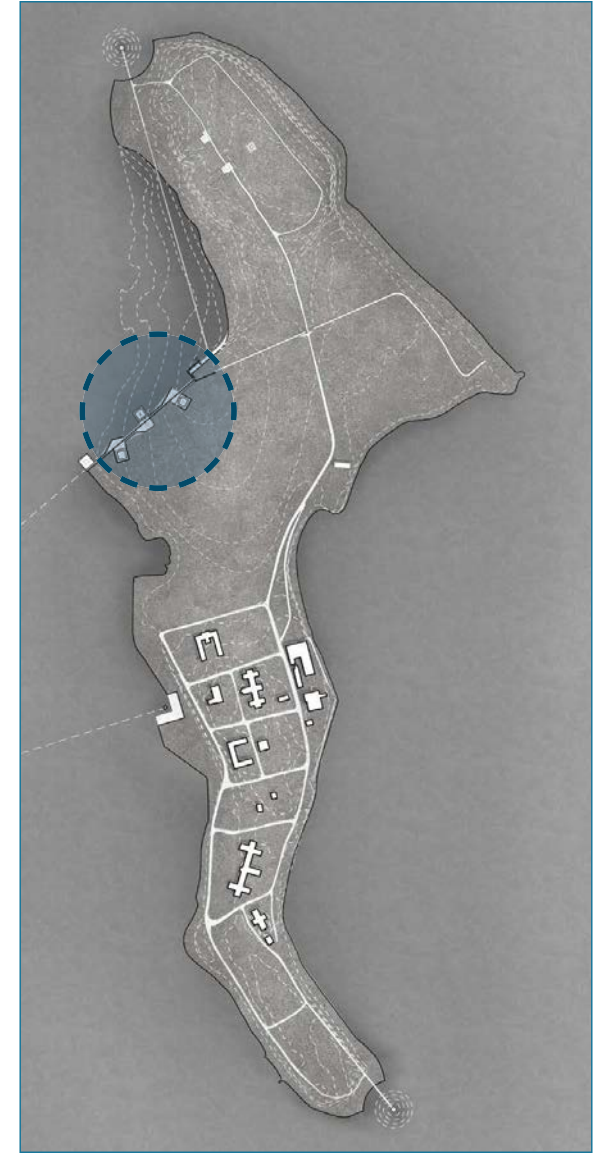

ENLARGED MASTER PLAN - PROPOSED
SCALE: NOT TO SCALE

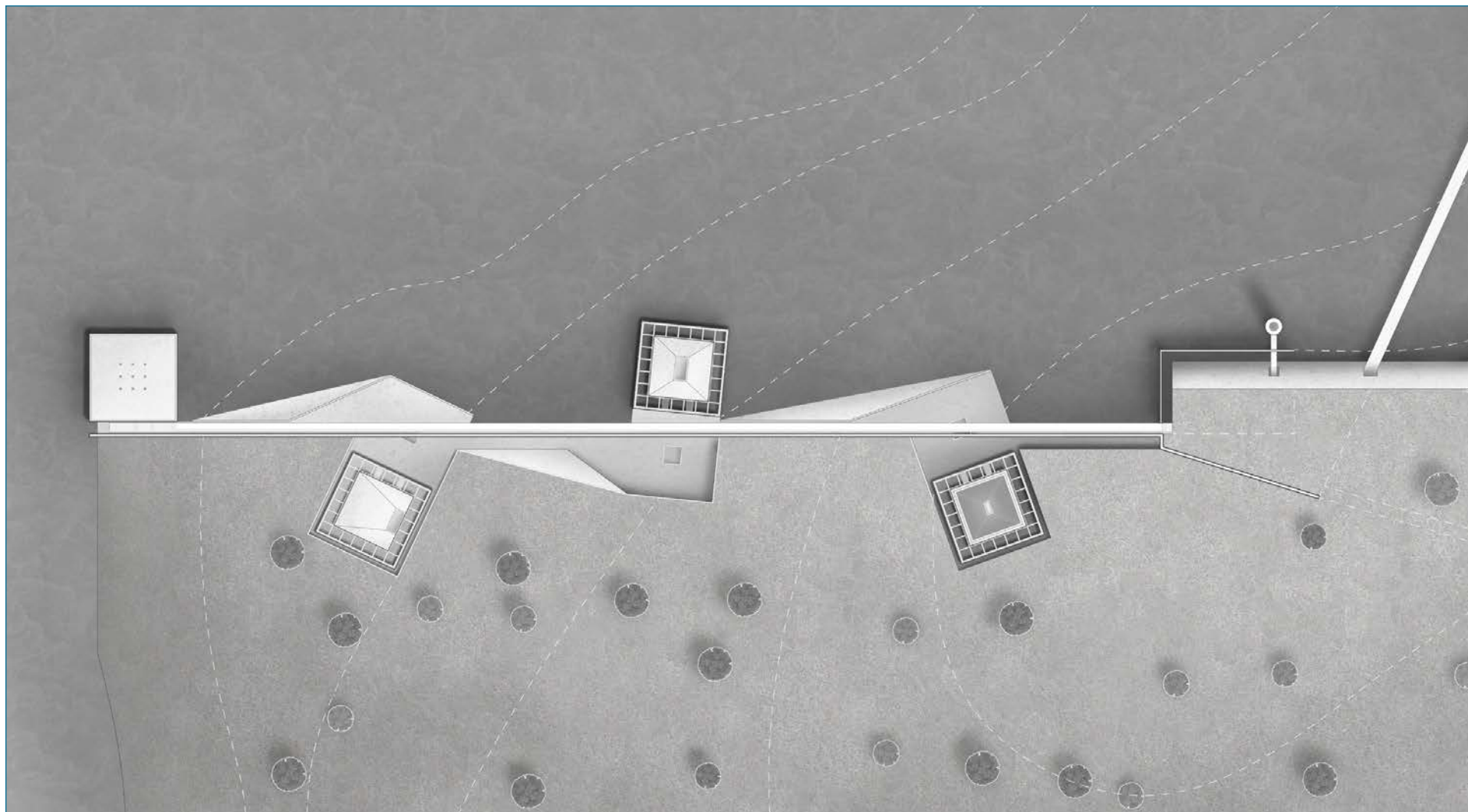

ENLARGED MASTER PLAN - ROOF PLAN
SCALE: NOT TO SCALE



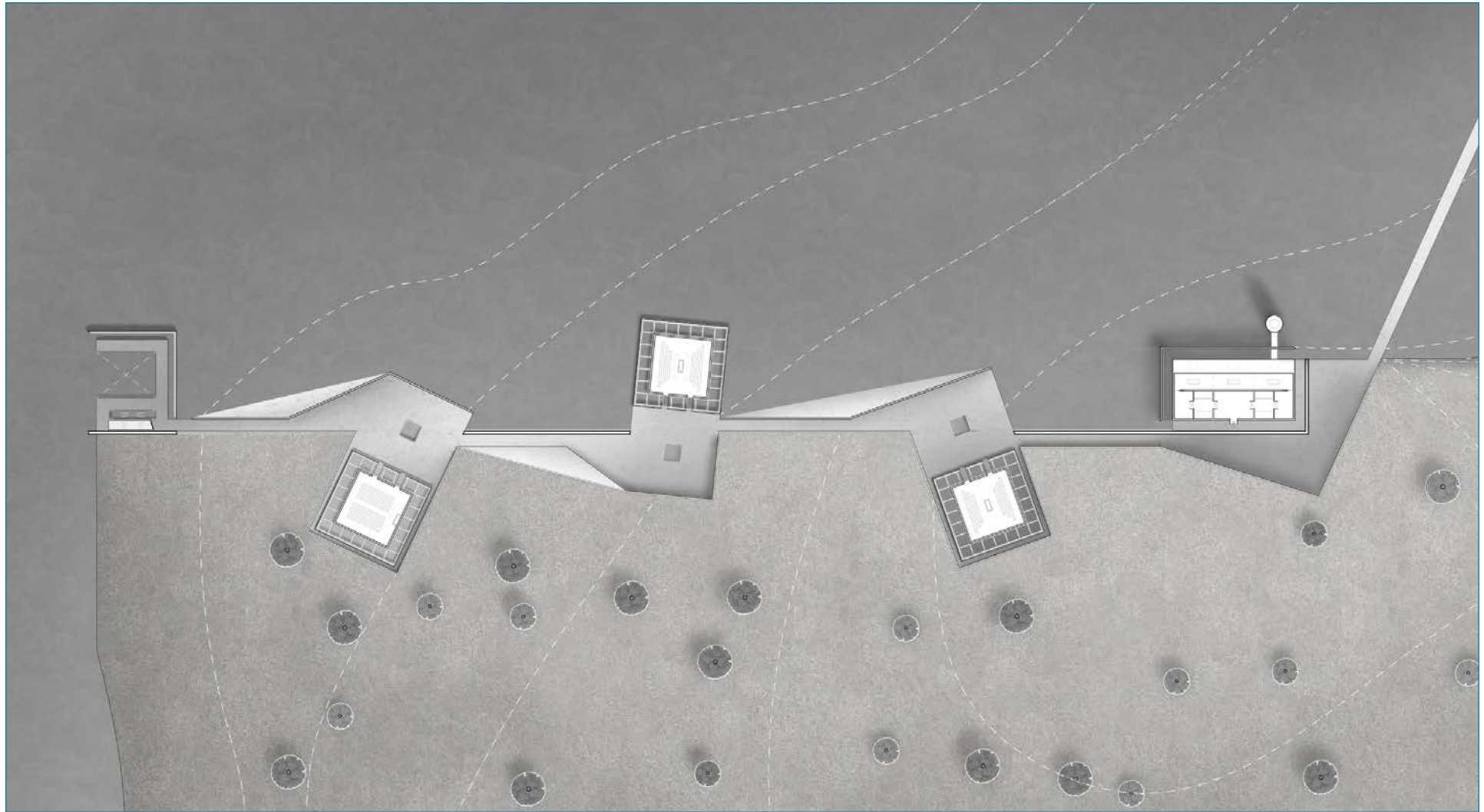

ENLARGED MASTER PLAN - FLOOR PLAN
SCALE: NOT TO SCALE



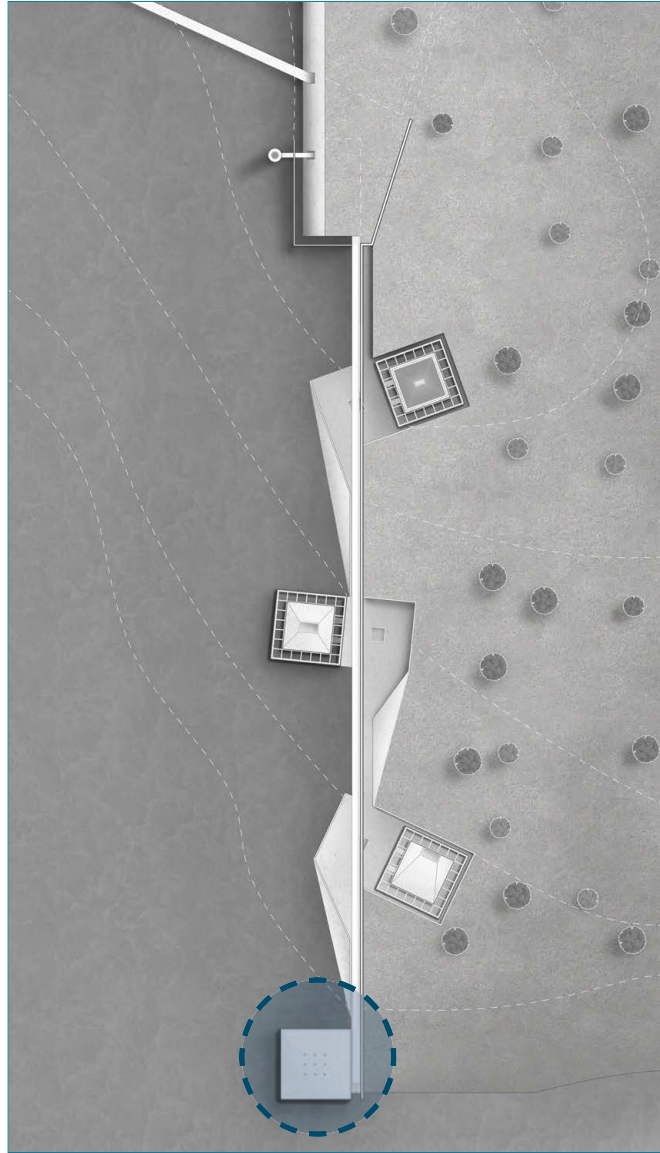

ENLARGED MASTER PLAN - FLOOR PLAN
SCALE: NOT TO SCALE

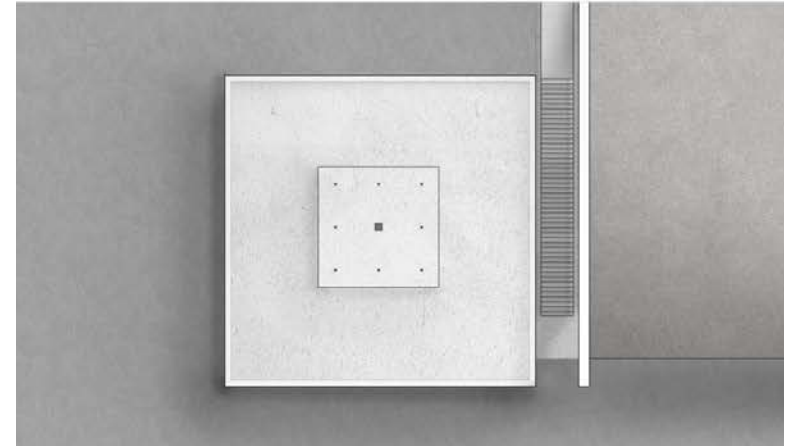

ARRIVAL PAVILION - ROOF PLAN
SCALE: NOT TO SCALE

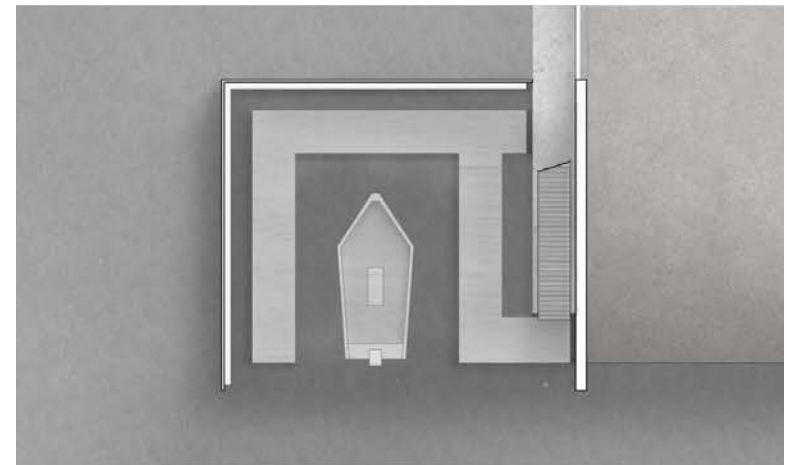

ARRIVAL PAVILION - FLOOR PLAN
SCALE: NOT TO SCALE

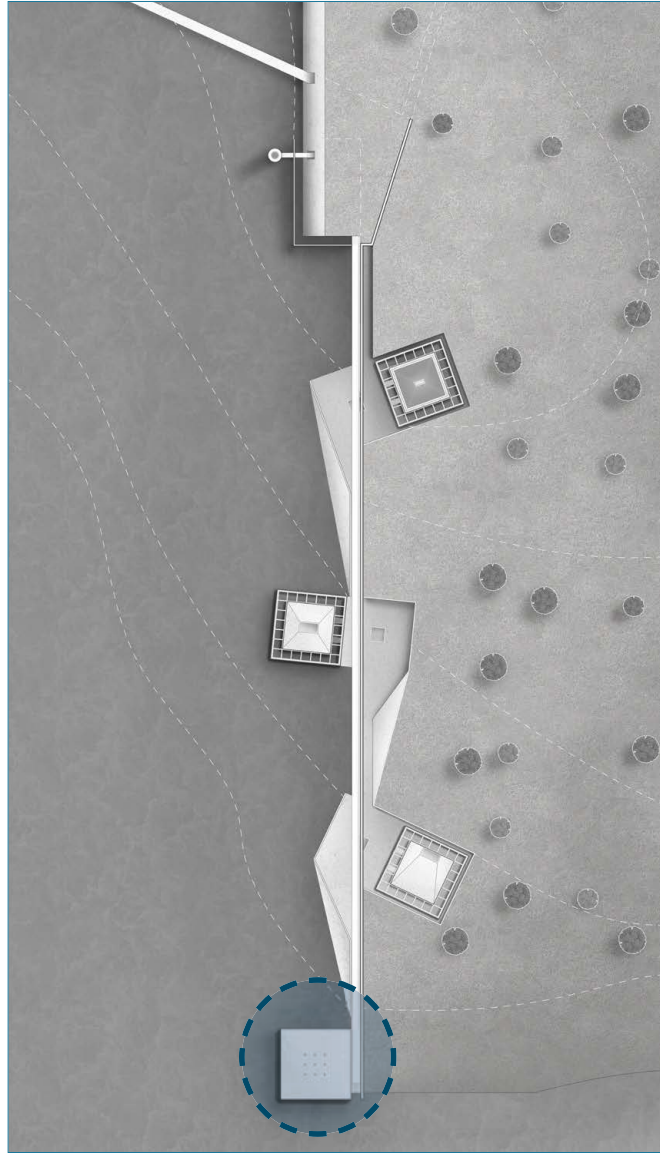

ENLARGED MASTER PLAN - FLOOR PLAN
SCALE: NOT TO SCALE

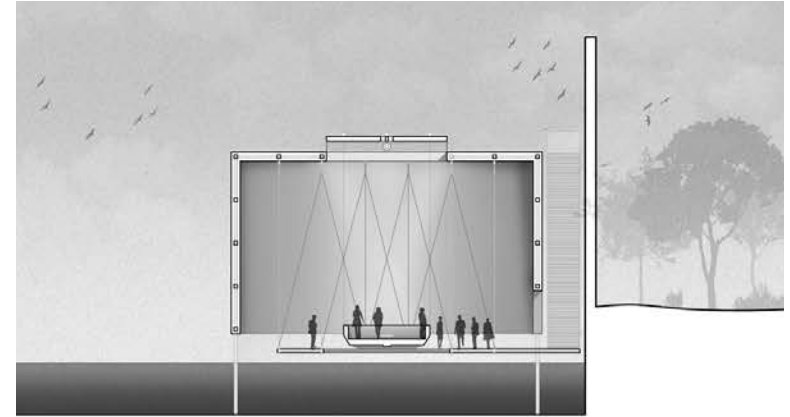

ARRIVAL PAVILION - SECTION I
SCALE: NOT TO SCALE

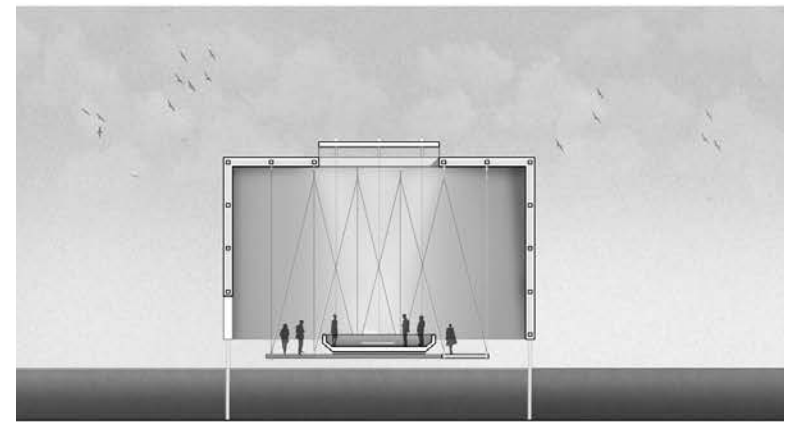

ARRIVAL PAVILION - SECTION II
SCALE: NOT TO SCALE

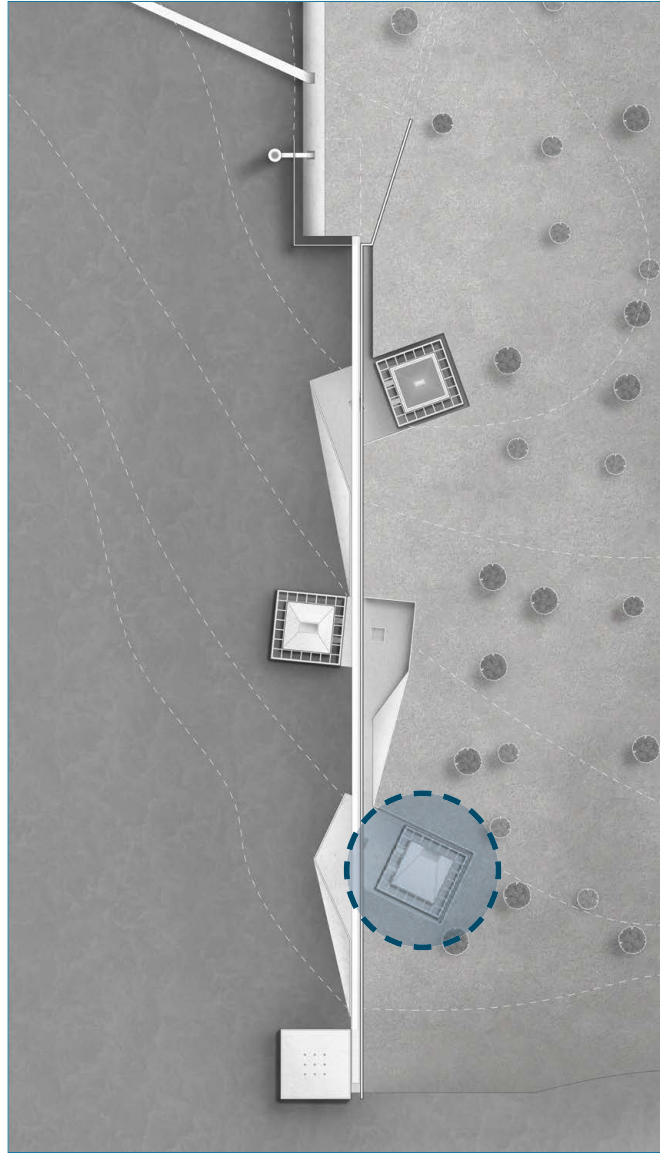

ENLARGED MASTER PLAN - FLOOR PLAN
SCALE: NOT TO SCALE

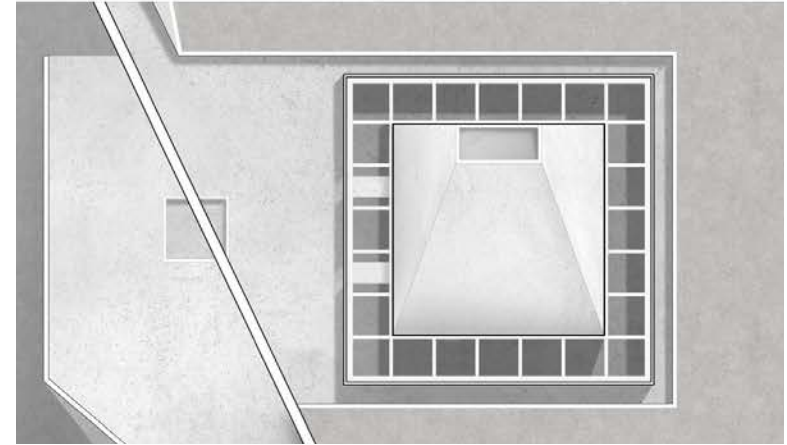

MORNING PAVILION - ROOF PLAN
SCALE: NOT TO SCALE

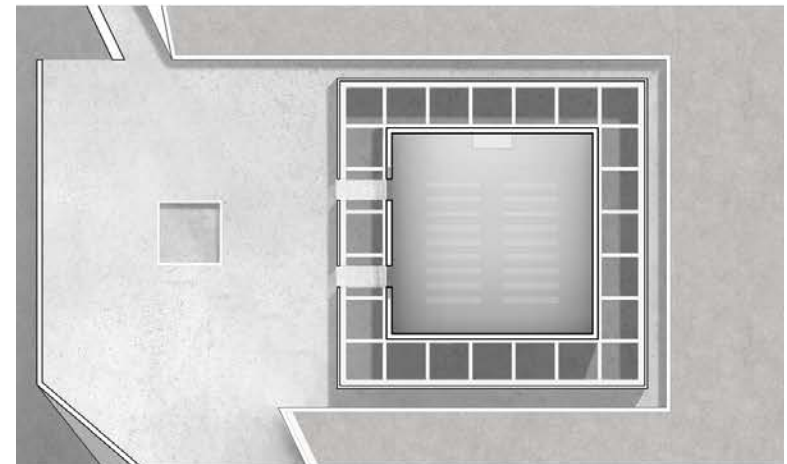

MORNING PAVILION - FLOOR PLAN
SCALE: NOT TO SCALE

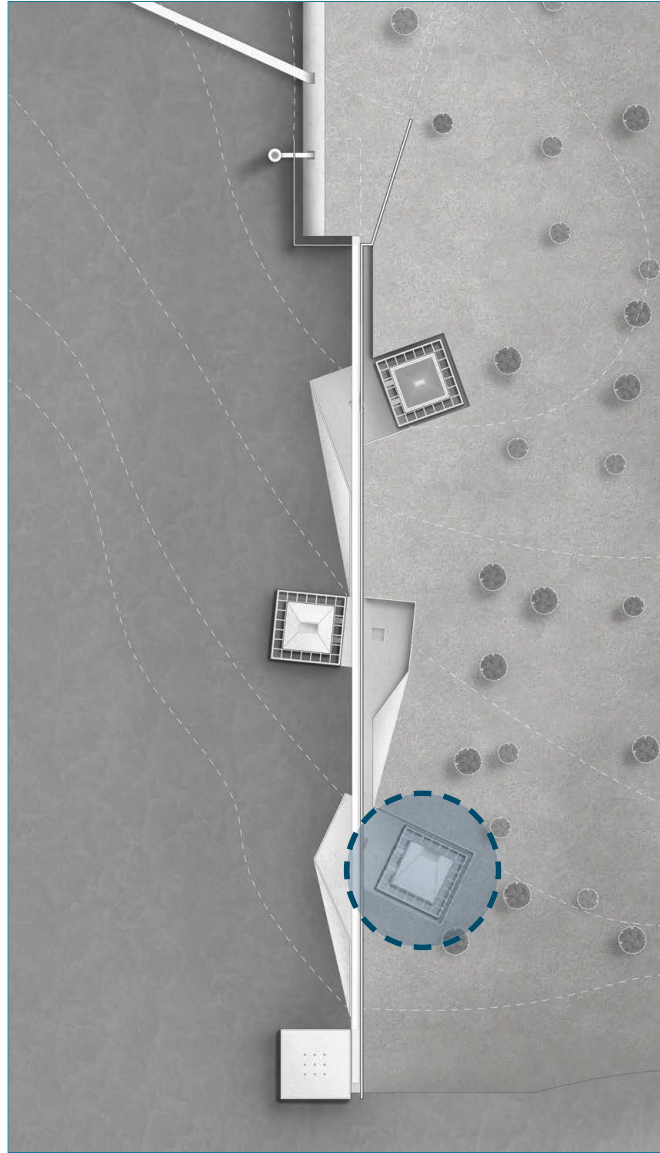

ENLARGED MASTER PLAN - FLOOR PLAN
SCALE: NOT TO SCALE

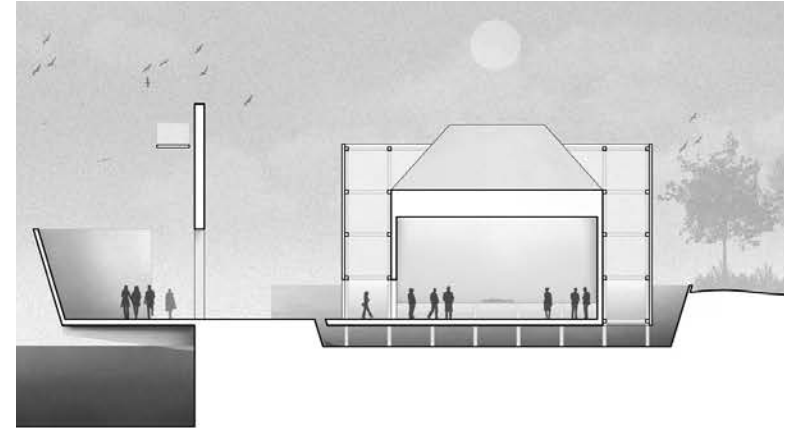

MORNING PAVILION - SECTION I
SCALE: NOT TO SCALE

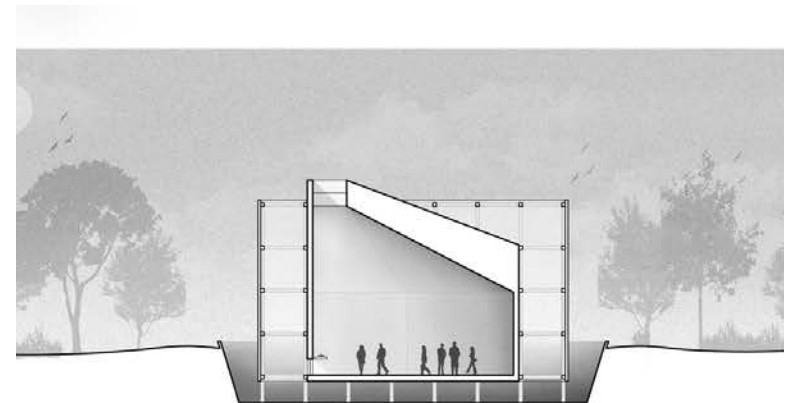

MORNING PAVILION - SECTION II
SCALE: NOT TO SCALE

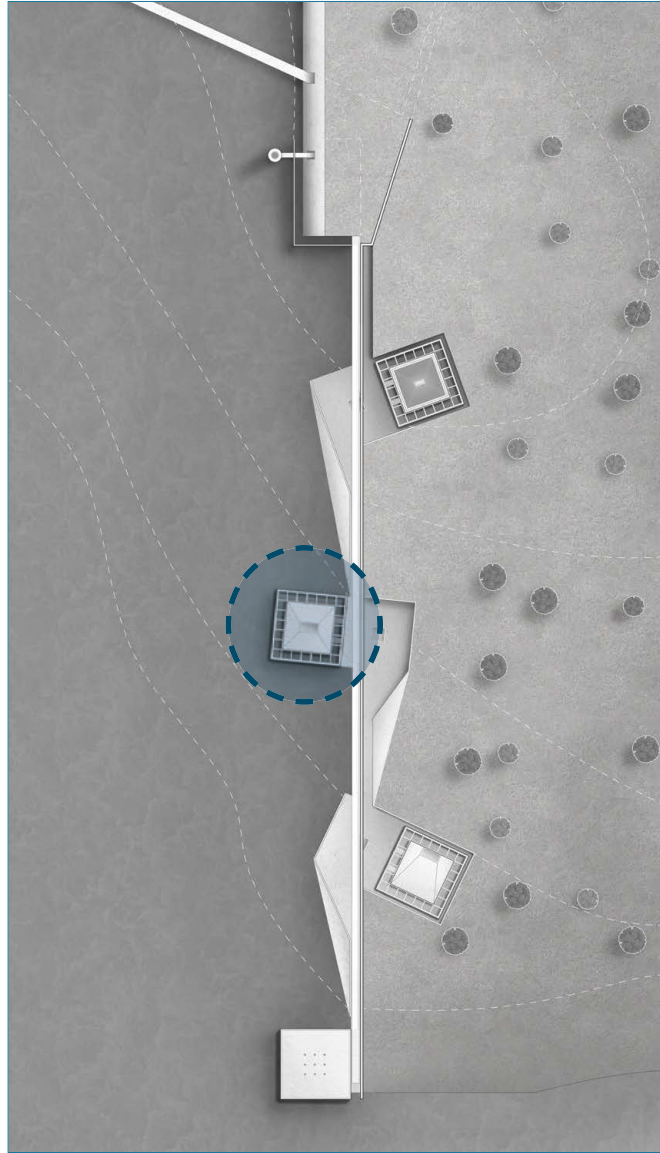

ENLARGED MASTER PLAN - FLOOR PLAN
SCALE: NOT TO SCALE

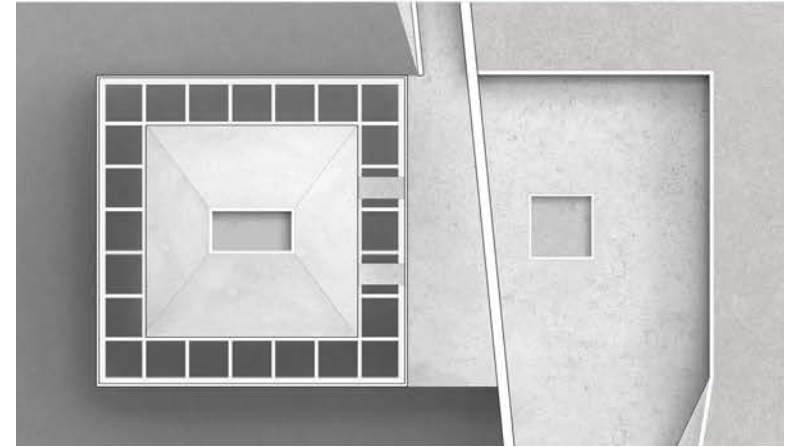

AFTERNOON PAVILION - ROOF PLAN
SCALE: NOT TO SCALE

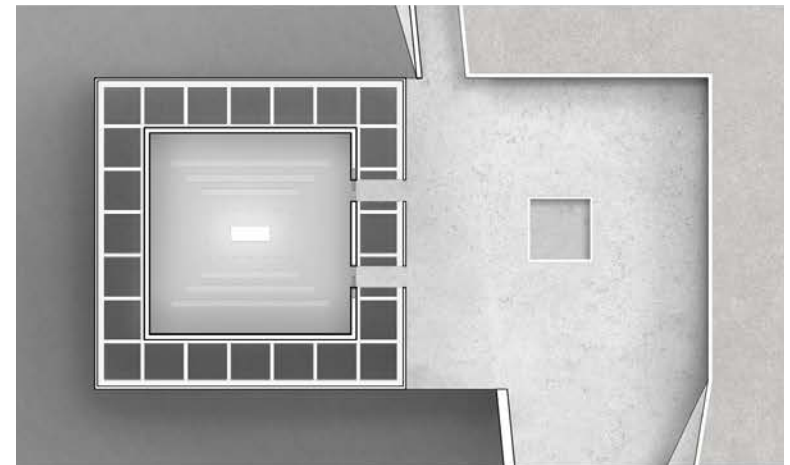

AFTERNOON PAVILION - FLOOR PLAN
SCALE: NOT TO SCALE

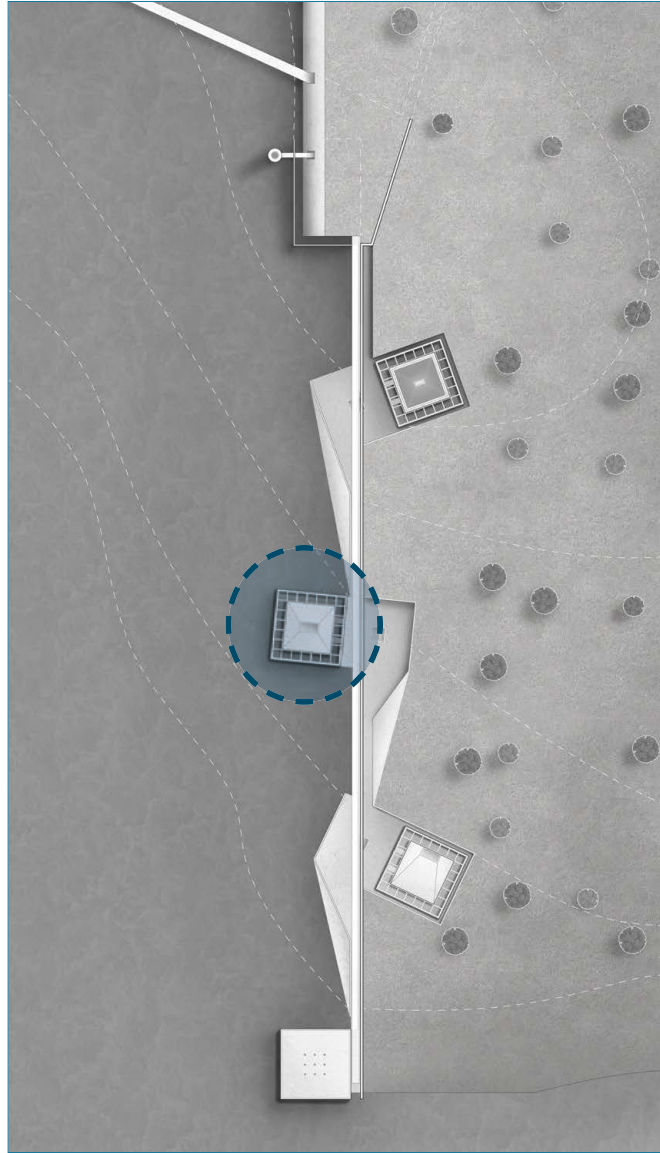

ENLARGED MASTER PLAN - FLOOR PLAN
SCALE: NOT TO SCALE

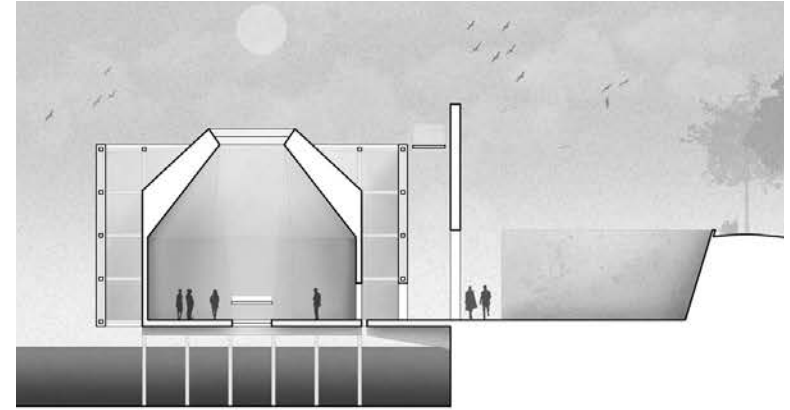

AFTERNOON PAVILION - SECTION I
SCALE: NOT TO SCALE

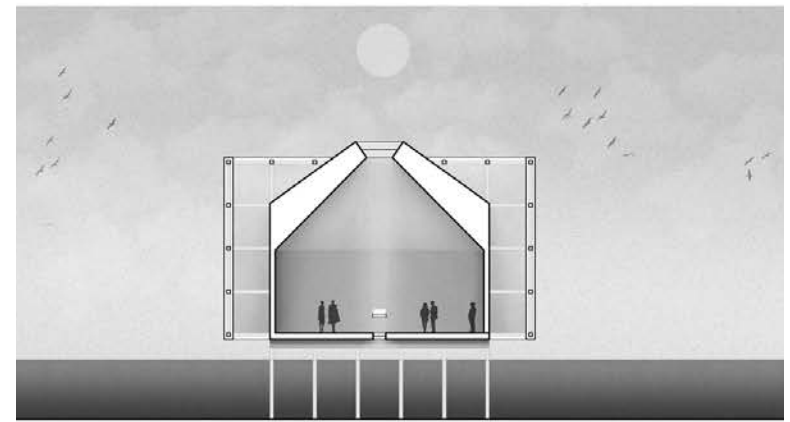

AFTERNOON PAVILION - SECTION II
SCALE: NOT TO SCALE

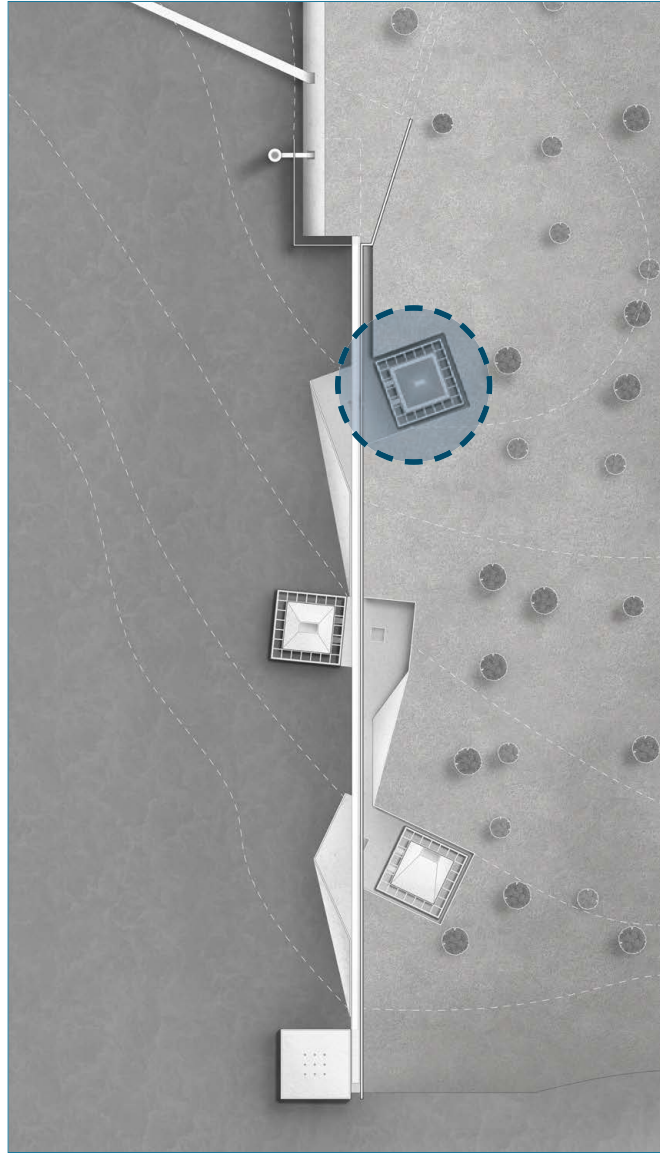

ENLARGED MASTER PLAN - FLOOR PLAN
SCALE: NOT TO SCALE

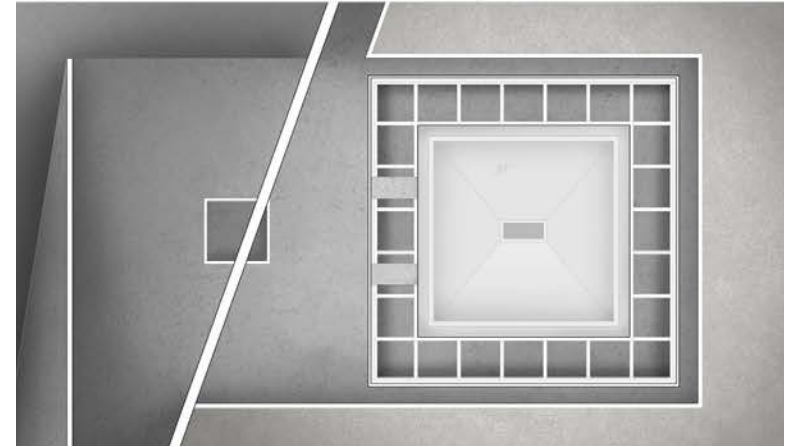

NIGHT PAVILION - ROOF PLAN
SCALE: NOT TO SCALE

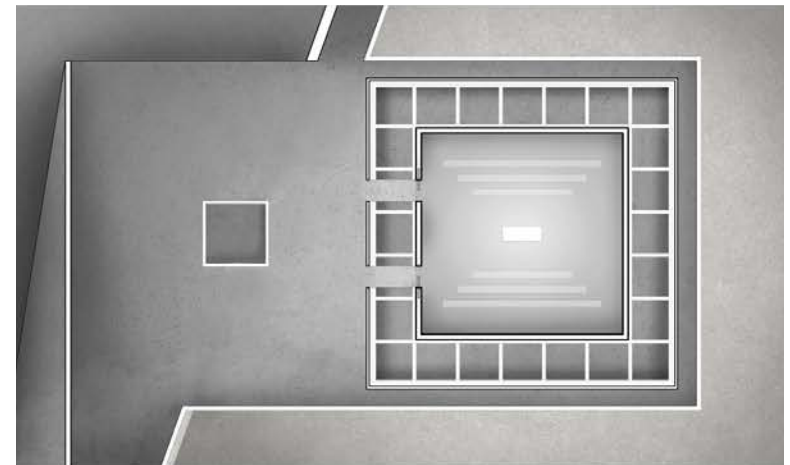

NIGHT PAVILION - FLOOR PLAN
SCALE: NOT TO SCALE

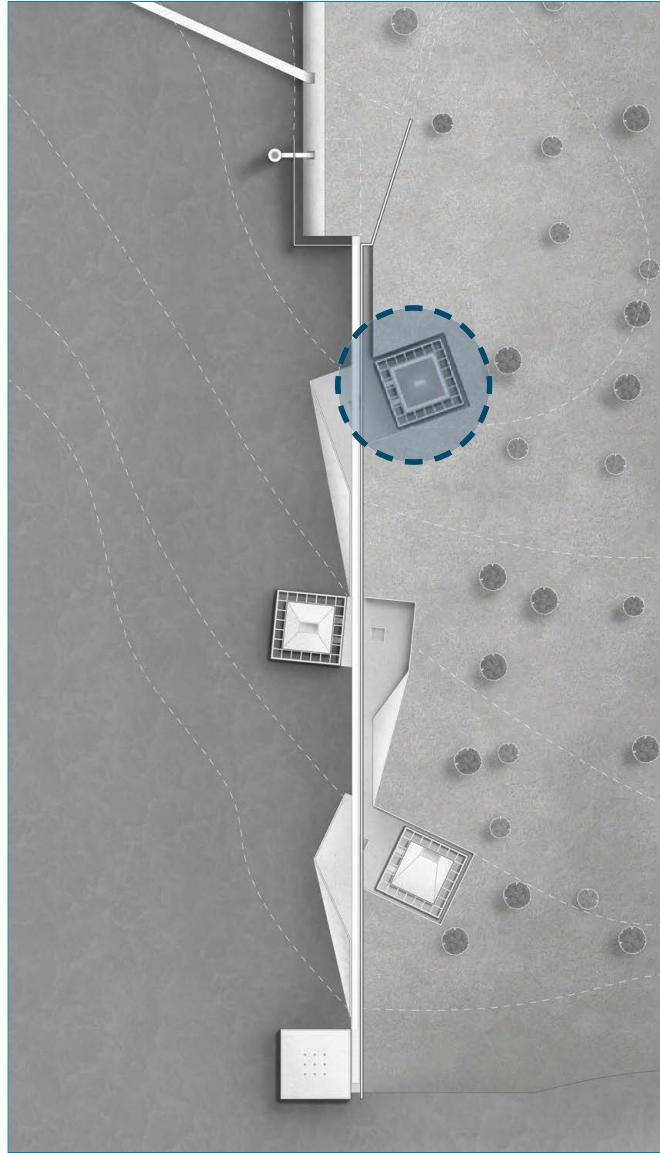

ENLARGED MASTER PLAN - FLOOR PLAN
SCALE: NOT TO SCALE

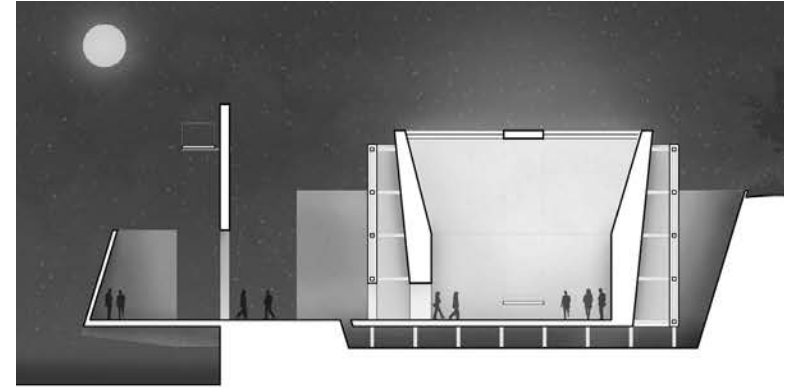

NIGHT PAVILION - SECTION I
SCALE: NOT TO SCALE

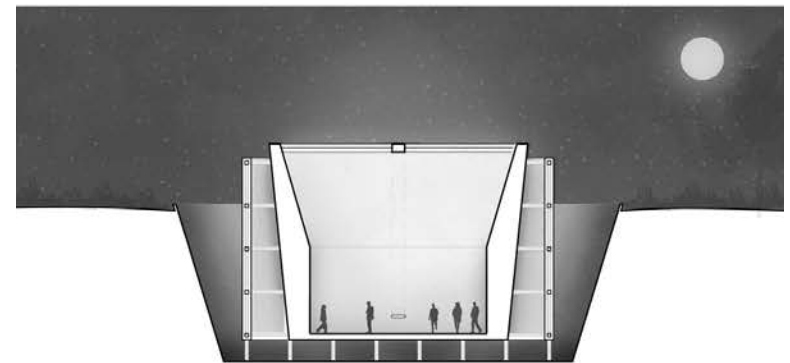

NIGHT PAVILION - SECTION II
SCALE: NOT TO SCALE

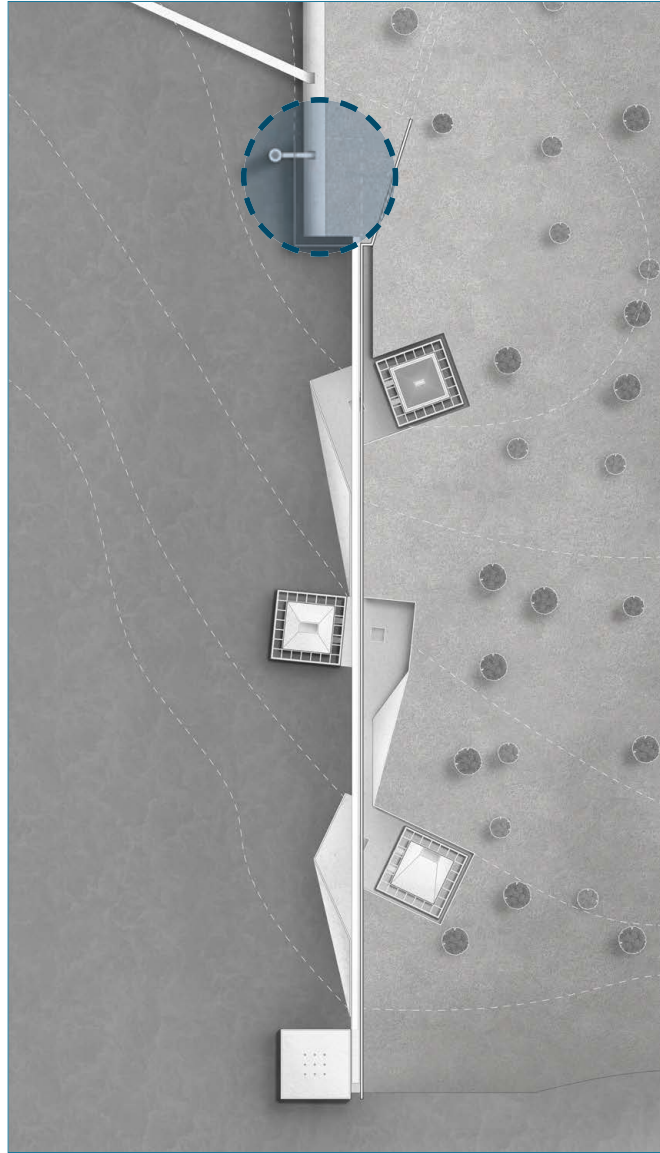

ENLARGED MASTER PLAN - FLOOR PLAN
SCALE: NOT TO SCALE

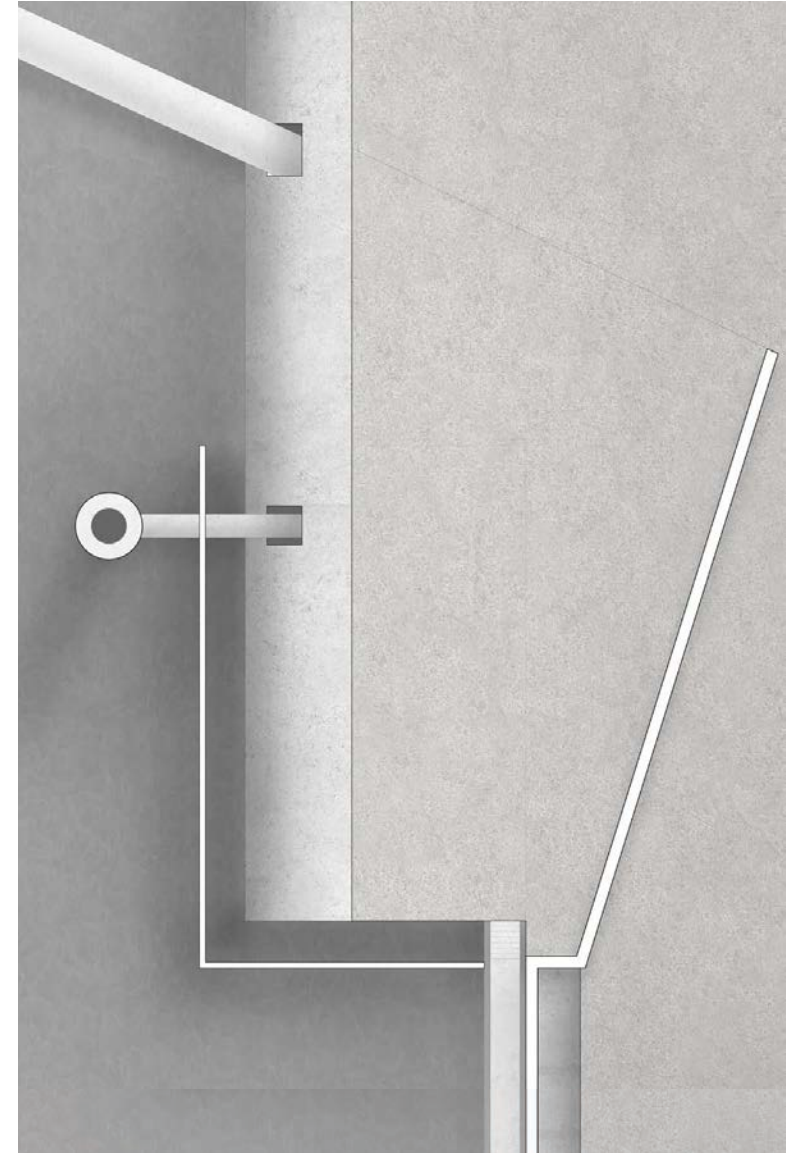

CREMATORIUM - ROOF PLAN
SCALE: NOT TO SCALE

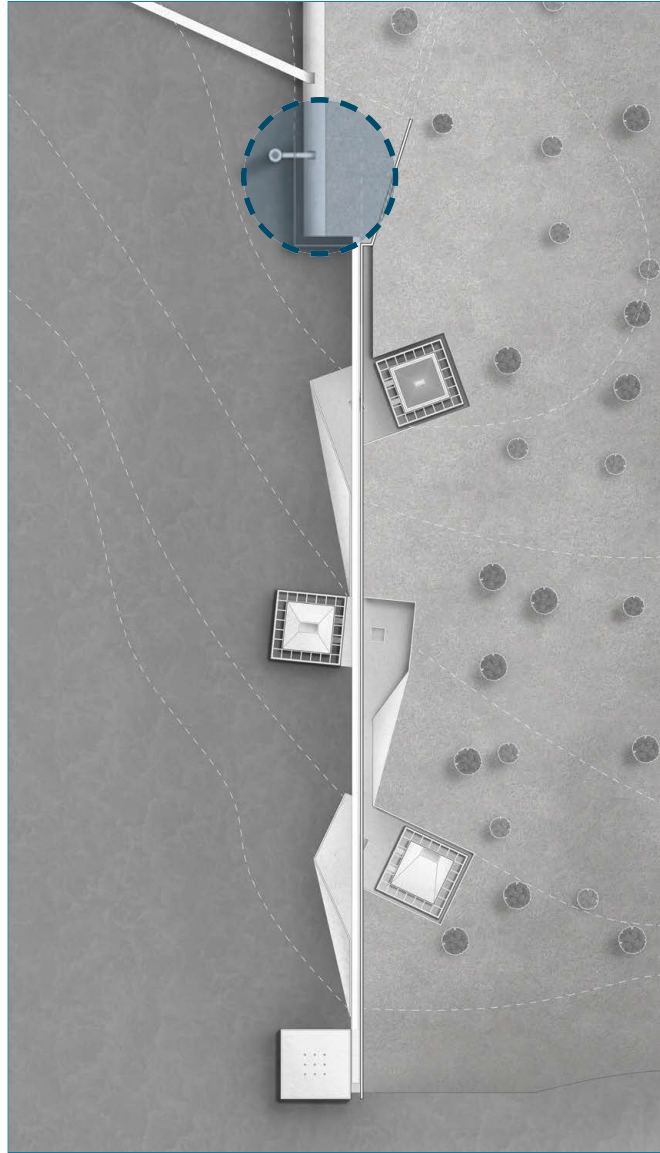

ENLARGED MASTER PLAN - FLOOR PLAN
SCALE: NOT TO SCALE

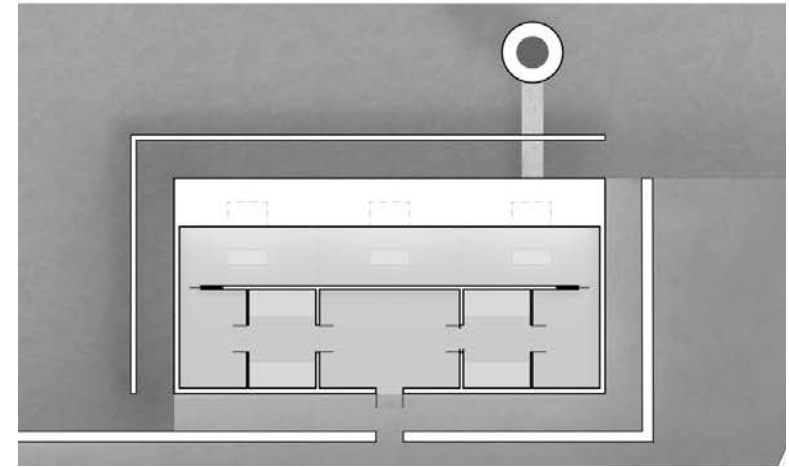

CREMATORIUM - FLOOR PLAN
SCALE: NOT TO SCALE

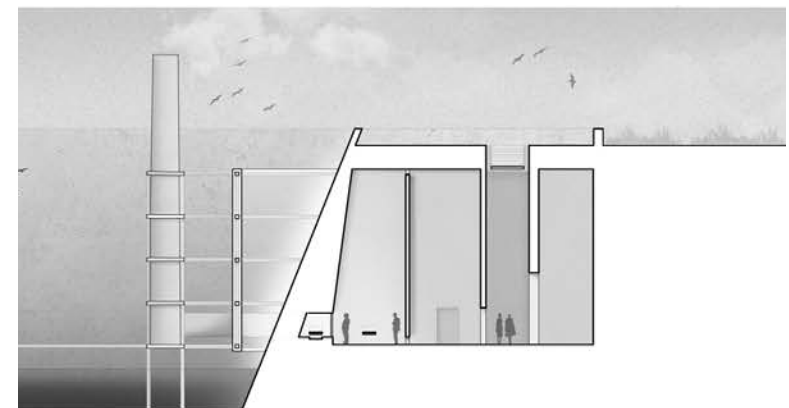

CREMATORIUM - SECTION I
SCALE: NOT TO SCALE

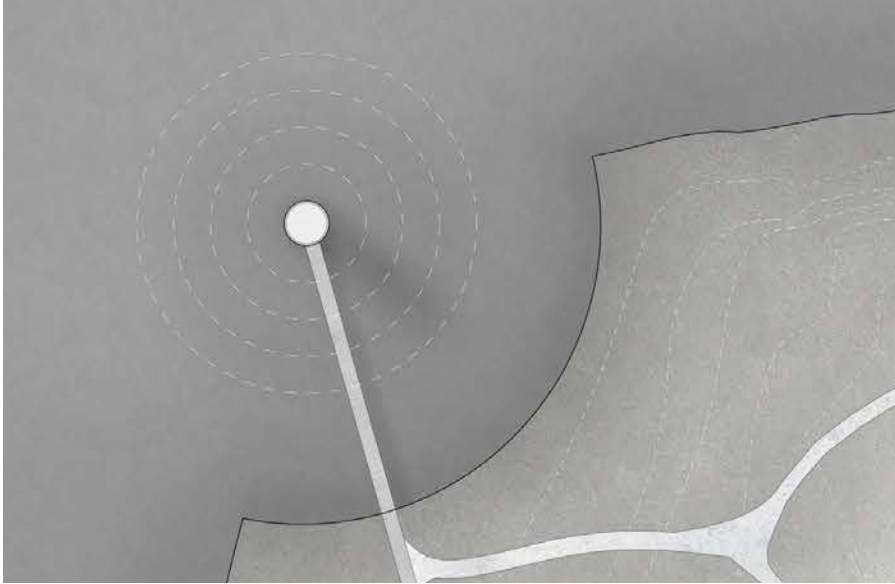

SUNSET MEMORIAL- SITE PLAN
SCALE: NOT TO SCALE

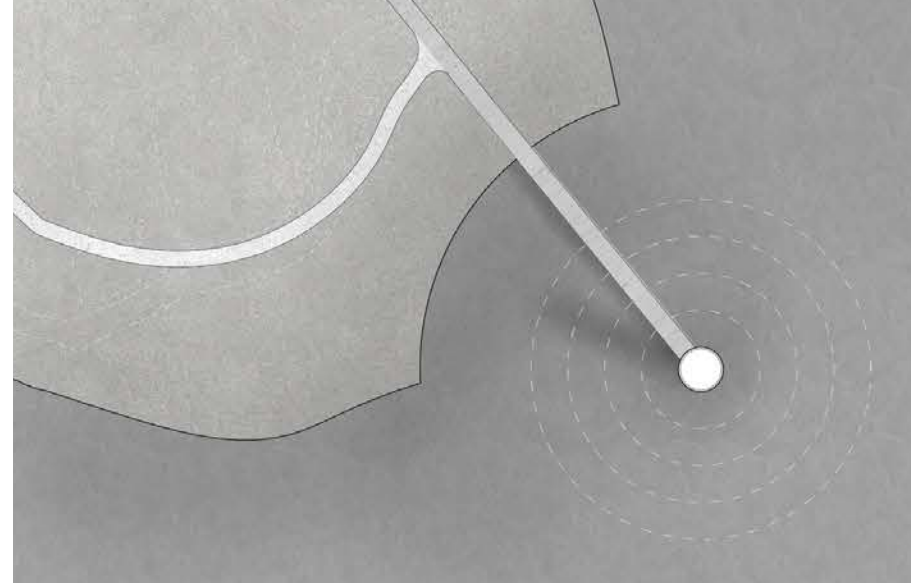

SUNRISE MEMORIAL- SITE PLAN
SCALE: NOT TO SCALE

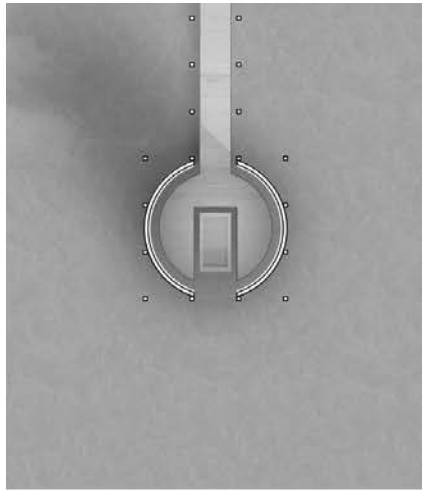

SUNSET MEMORIAL- FLOOR PLAN
SCALE: NOT TO SCALE

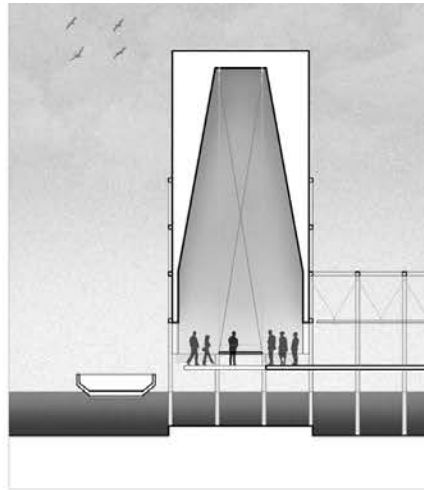

SUNSET MEMORIAL- SECTION I
SCALE: NOT TO SCALE

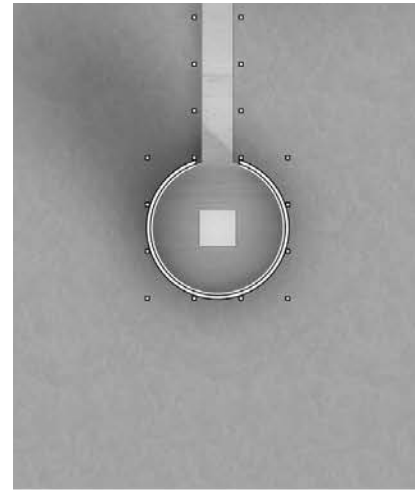

SUNRISE MEMORIAL- FLOOR PLAN
SCALE: NOT TO SCALE

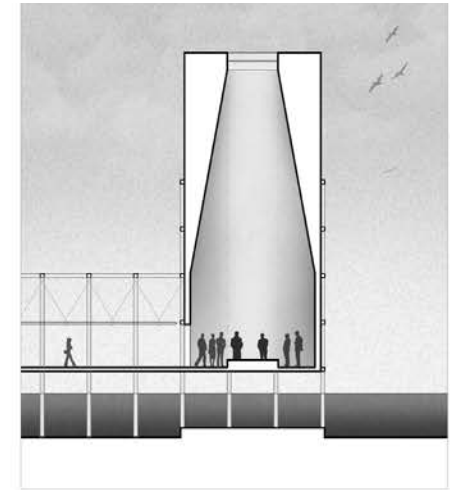

SUNRISE MEMORIAL- SECTION I
SCALE: NOT TO SCALE